



User Manual

The essentials of Imaging

www.minolta.com

Fax unit for Di152/183 FX-1 Di152f/Di183f

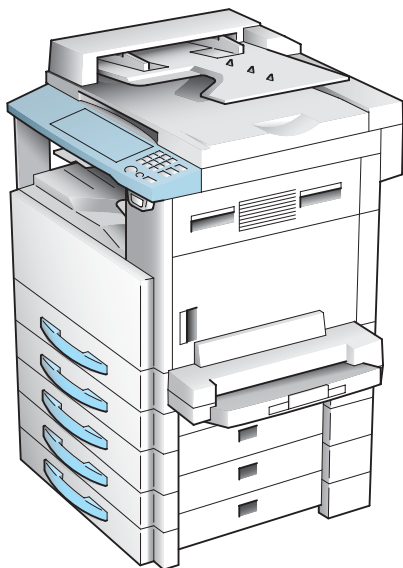

Energy Star®

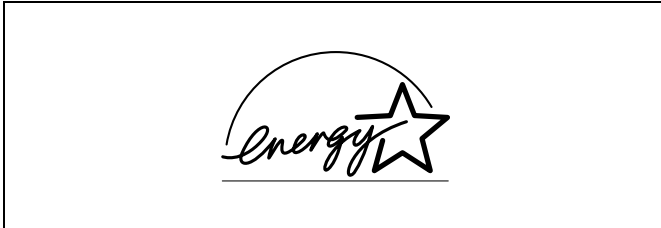

As an ENERGY STAR® Partner, we have determined that this machine meets the ENERGY STAR® Guidelines for energy efficiency.

What is an ENERGY STAR® Product?

An ENERGY STAR® product has a special feature that allows it to automatically switch to a “low-power mode” after a period of inactivity. An ENERGY STAR® product uses energy more efficiently, saves you money on utility bills and helps protect the environment.

Recycled Paper (USA market only)

Your Minolta machine has been designed to use the following Recycled Paper.

Minolta Recycled Bond: Item No. 8925 701

20% Post Consumer Waste

Contents

1 Introduction

1.1	END USER LICENSE AGREEMENT	1-1
	1. SOFTWARE	1-1
	2. LICENSE AGREEMENT	1-1
	3. LICENSE	1-1
	4. RESTRICTIONS	1-2
	5. LIMITED WARRANTY	1-2
	6. LIMITATION OF REMEDIES	1-2
	7. TERMINATION	1-3
	8. GOVERNING LAW	1-3
	9. GOVERNMENT END USERS	1-3
1.2	We Want You to Be a Satisfied Customer	1-4
	For U.S.A. Users	
	FCC Part 15-Radio Frequency Devices	1-4
	For Canada Users	
	Interference-Causing Equipment Standard (ICES-003 Issue 3)	1-4
1.3	Safety Information	1-6
	Warning and Precaution Symbols	1-6
	Meaning of Symbols	1-6
	WARNING	1-7
	CAUTION	1-8
	Precautions for Routine Use	1-9
	FCC Part 68 – Telecommunication Devices	1-10
	Warning For The Setting Of Header And Footer	1-11
	IC CS-03-Telecommunication Devices	1-11
	Laser Safety	1-12
	Internal Laser Radiation	1-12
	CDRH Regulation	1-13
	Laser Safety Label	1-14
	Ozone Release	1-14
	Notice for Ni-MH Batteries	1-15
1.4	About the User Manual	1-16
	Explanation of Manual Conventions	1-16
	[] key	1-16
1.5	Explanation of Basic Concepts and Symbols	1-17
	Paper Feeding	1-17
	“Width” and “Length”	1-18
	Paper Orientation	1-18

2 Precautions

2.1 Installation Precautions	2-1
Installation site	2-1
Power source.....	2-1
Space Requirements	2-2
2.2 Operation Precautions	2-3
Operating Environment.....	2-3
Proper Use	2-3
Transporting the Machine.....	2-4
Care of Machine Supplies	2-4
2.3 Legal Restrictions on Copying.....	2-5

3 Before Making Copies or Faxing

3.1 Available Copy Features.....	3-1
3.2 Available Fax Features.....	3-6
3.3 Components and Their Functions	3-8
3.4 Part Names and Their Functions	3-10
Main Unit	3-10
Inside of Main Unit.....	3-12
Automatic Document Feeder (Optional)	3-13
Multiple Bypass Tray (Optional)	3-14
Paper Feed Cabinet (Optional).....	3-15
Shifting Unit (Optional)	3-16
Job Tray (Optional).....	3-17
3.5 Names of Control Panel Parts and Their Functions.....	3-18
Control Panel Parts and Their Functions.....	3-18
Display Indications.....	3-22
3.6 Useful Operations.....	3-24
Cancelling Settings.....	3-24
Auto Panel Reset.....	3-24
Energy Saver Mode (Preheat Mode).....	3-25
Auto Shut-Off.....	3-25
Queued Copy Jobs.....	3-25
Interrupting Copy Jobs	3-26
Auto Paper Source Change Feature	3-26
Access Numbers	3-26
To enter an access number.....	3-27
Printing From the Computer	3-27
Scanning From the Computer	3-27

3.7	Power Switch and Default Settings	3-28
	Turning the Machine On and Off	3-28
	To turn on the machine	3-28
	To turn off the machine	3-28
	Turning On the Machine	3-29
	Default Settings	3-29
3.8	Selecting and Checking Initial Settings	3-30
	Required Settings	3-30
	Checking the Initial Settings	3-30
	To set the current date and time	3-31
	To specify the user fax number	3-32
	To program the user name	3-33
	Specifying the Phone Dialing System	3-34
	To specify the telephone dialing system	3-34
	Specifying the Phone Wiring System	3-35
	To specify the telephone wiring system	3-35
3.9	Entering Text	3-36
	Inputting Example	3-37
3.10	Copy Paper	3-39
	Paper Specifications	3-39
	Print Area	3-42
	Paper Storage	3-42
3.11	Original Documents	3-43
	Document Feeding	3-43
	Precautions for Loading Documents into the Automatic Document Feeder	3-44
	Precautions for Positioning Documents on the Original Glass	3-44

4 Basic Copy Operations

4.1	Loading the Document	4-1
	With the Automatic Document Feeder	4-1
	To load the document	4-1
	To load documents of mixed sizes	4-2
	With the Original Glass	4-5
	To position sheet documents	4-5
	To position translucent or transparent documents	4-6
	To position a book	4-7
4.2	Making Copies	4-9
	To make a simple copy	4-9

4.3	Selecting the Paper Source	4-11
	To make copies using the “Auto Paper” function	4-11
	To copy with a manually selected paper size	4-12
	To copy onto special paper (1st Tray)	4-13
4.4	Making Copies on Manually Fed Paper	4-14
	Paper That Can Be Fed Manually	4-14
	Copying Onto Manually Fed Paper	4-15
	To copy using the Manual Bypass Tray	4-15
	To copy using the Multiple Bypass Tray	4-17
	To copy onto a custom paper size	4-19
4.5	Specifying a Zoom Setting	4-21
	Zoom Settings	4-21
	To make copies using the “AUTO” zoom setting	4-21
	To make copies using a specific zoom setting	4-22
	To make copies using the “X/Y Zoom” function	4-23
4.6	Specifying the Copy Density (“Auto/Photo” function)	4-25
	To make copies after specifying a copy density	4-26
4.7	Interrupting Copy Jobs	4-27
	To interrupt a copy job	4-27

5 Advanced Copy Operations

5.1	Single-Sided Copies	5-1
	To make copies using the “2in1” (or “4in1”) copy function	5-2
	To make copies using the “Book Separation” function	5-3
5.2	Finishing Copies (“Sort” and “Group” functions)	5-5
	Sorting	5-6
	Grouping	5-7
	Specifying Finishing	5-8
	To make copies using a Finishing function	5-8
5.3	Erasing Sections of Copies	5-9
	Precautions on the Erased Margin Location	5-10
	Setting the “Erase” Function	5-11
	To make copies using an “Erase” setting	5-11
5.4	Negative/Positive Inverted Copying	5-12
	To make copies using the negative/positive inverted copy function	5-12
5.5	Making Copies for Filing (“File Margin” function)	5-13
	Precautions on the Binding Margin Location	5-13
	To make copies using the “File Margin” function	5-13

5.6	Programmed Copy Jobs	5-15
	To store a copy program	5-15
	To recall a copy program	5-16

6 Faxing

6.1	Document Specifications for Transmission	6-1
6.2	Basic Faxing	6-3
	To fax using the Automatic Document Feeder	6-3
	To fax documents positioned on the Original Glass.....	6-5
	If the Memory Becomes Full While Scanning Fax Documents	6-7
6.3	Transmission Settings	6-8
	Adjusting the Fax Resolution	6-8
	To specify the resolution	6-8
6.4	Dialing	6-10
	To fax by entering the fax number directly using the 10-Key Pad	6-11
	To fax using one-touch dialing	6-12
	To fax using speed dialing	6-13
	To fax using group dialing	6-14
	To fax using program dialing.....	6-15
	To fax using combination dialing.....	6-16
	To fax using the phone book.....	6-17
	To search the phone book	6-18
	To redial the last recipient called.....	6-19
6.5	Receiving	6-20
	Receiving Automatically/Manually.....	6-20
6.6	Checking Transmission Results	6-22
	To check the transmission result.....	6-22

7 Fax Transmission/Reception Methods

7.1	Transmission Methods	7-1
	Memory Transmission.....	7-1
	Book Transmission.....	7-1
	Manual Transmission.....	7-1
	To send a fax manually	7-2
	Batch Transmission.....	7-3
	To fax using batch transmission.....	7-3
	Broadcast Transmission.....	7-4
	To fax using broadcast transmission.....	7-4
	Timer Transmission.....	7-7
	To fax using timer transmission	7-7
	Mailbox Transmission	7-9



To fax using mailbox transmission	7-9
Relay Initiation Transmission.....	7-11
To fax using relay initiation transmission.....	7-11
Relay Broadcast Transmission	7-13
Direct Transmission	7-14
To fax using direct transmission	7-14
Polling Transmission	7-16
To set up polling transmission	7-16
To delete a document from the polling transmission setup	7-18
Cancelling (Deleting) a Document Queued in the Memory for Transmission	7-19
To cancel a queued document	7-19
7.2 Reception Methods	7-21
Manual Reception.....	7-21
To receive a fax manually.....	7-21
Memory Reception	7-21
Mailbox Reception	7-22
To retrieve a document from a mailbox	7-22
Polling Reception.....	7-23
To receive a fax using polling reception	7-23
7.3 Using F codes	7-25
Using Mailboxes	7-26
Specifying F codes	7-27
When sending faxes	7-27
Programming recipients.....	7-28

8 Expanded Functions by Connecting a Computer

8.1 Setting Up for PC Faxing/PC Scanning	8-1
Modem Specifications	8-1
8.2 Setting Up for PC Scanning.....	8-1

9 Utility Mode – Copy Functions

9.1 Specifying Machine Settings (“MACHINE SETTING” Menu)	9-2
To select the “MACHINE SETTING” menu	9-3
To set the “AUTO PANEL RESET” function.....	9-4
To set the “ENERGY SAVE MODE” (preheat mode) function	9-5
To set the “AUTO SHUT OFF” function.....	9-6
To specify the ADF (Automatic Document Feeder) scanning image quality (“DENSITY(ADF)” function)	9-7
To specify the printing density (“PRINT DENSITY” function)	9-8
To set the “LCD CONTRAST” function.....	9-8
To set the “BUZZER VOLUME” function.....	9-9
To set the “LANGUAGE” function.....	9-9

	To set the “INITIAL MODE” function	9-10
9.2	Setting Up the Paper Sources (“PAPER SOURCE SETUP” Menu).....	9-11
	To select the “PAPER SOURCE SETUP” menu.....	9-12
	To specify the automatic paper size detection units (“INCH/METRIC” function)	9-13
	To specify the size of paper loaded into the 1st Tray (“TRAY1 PAPER” function).....	9-14
	To set the “AUTO SELECT” function	9-16
9.3	Specifying User-Managed Service Tasks (“USER MANAGEMENT” Menu).....	9-17
	To perform the “DRUM DEHUMIDIFY” function	9-17
	To perform the “TONER REPLENISHER” function.....	9-18
9.4	Specifying Administrative Settings (“ADMIN. MANAGEMENT” Menu).....	9-19
	To select the “ADMIN. MANAGEMENT” menu.....	9-20
	To set the “AUTO SHUT OFF” function	9-21
	To turn on/off user (section) management	9-22
	To register user (section) access numbers	9-23
	To change/delete user (section) access numbers	9-24
	To display/clear the total count for a specific account.....	9-26
	To print the total counts for all accounts (sections).....	9-28
	To clear the total counts for all accounts.....	9-29
	To set the “REMOTE MONITOR” function.....	9-30
9.5	Specifying Copy Settings (“COPY SETTING 1” & “COPY SETTING 2” Menus)	9-31
	To select the “COPY SETTING 1” menu	9-32
	To set the “PAPER PRIORITY” function	9-33
	To set the “DENSITY PRIORITY” function.....	9-34
	To set the “AUTO” density level (“DENSITY LEVEL(A)” function)	9-34
	To set the manual density level (“DENSITY LEVEL(M)” function).....	9-35
	To set the “BINDING POS.” function.....	9-35
	To specify the binding width (“MARGIN SETTING” function)	9-36
	To specify the erased width (“ERASE SETTING” function)	9-36
	To select the “COPY SETTING 2” menu	9-37
	To set the “MIXED ORIGINAL” function.....	9-38
	To set the “COPY PRIORITY” function	9-38
	To specify the default finishing mode (“OUTPUT PRIORITY” function).....	9-39
	To set the “4IN1 COPY ORDER” function	9-39
	To set the “CRISSCROSS MODE” function.....	9-40

10 Utility Mode – Fax Functions

10.1 Programming Fax Settings (“FAX REGISTRATION” Menu) ...	10-1
To select the “FAX REGISTRATION” menu	10-2
Setting Up One-Touch Dialing (“ONE-TOUCH DIAL” function)....	10-3
To program a one-touch dial key	10-4
To change/delete a programmed one-touch dial key	10-6
Setting Up Speed Dialing (“SPEED DIAL” function)	10-8
To program a speed dial number	10-8
To change/delete a programmed speed dial number	10-11
Setting Up Group Dialing (“GROUP DIAL” function)	10-13
To program a group of fax numbers	10-13
To change/delete a programmed group of fax numbers	10-14
Setting Up Program Dialing (“PROGRAM DIAL” function)	10-16
To set program dialing	10-16
To change/delete a programmed broadcast transmission	10-17
To change/delete a programmed timer transmission	10-19
To change/delete a programmed mailbox transmission	10-20
To change/delete a programmed polling reception	10-22
To change/delete a programmed relay initiation transmission ...	10-23
Setting Up Batch Transmissions (“BATCH TX” function)	10-25
To set batch transmitting	10-25
To change the batch transmission setting	10-27
To delete the batch transmission setting	10-28
Setting Up Mailboxes (“MAILBOX” function)	10-29
To register a mailbox	10-29
To delete a mailbox	10-30
Setting Up Relay Boxes (“RELAY BOX” function)	10-31
To program the relay box	10-32
To delete the relay box	10-34
10.2 Specifying Transmission Settings	
(“TX OPERATION” Menu)	10-35
To select the “TX OPERATION” menu	10-35
To specify the default scanning contrast	
(“SCAN CONTRAST” function)	10-36
To specify the default resolution setting	
(“RESOLUTION” function)	10-37
To set the “DEFAULT TX” function	10-38
To specify if one-touch dialing transmission (Copy mode) is	
allowed (“OT-DIAL IN COPY” function)	10-38
10.3 Specifying Reception Settings (“RX OPERATION” Menu) ...	10-39
To select the “RX OPERATION” menu	10-41
To select the memory reception mode	
(“MEMORY RX MODE” function)	10-42
To cancel memory reception	10-43
To set the “NO.of RINGS” function	10-44

To set the “REDUCTION RX” function.....	10-44
To set the “RX PRINT” function	10-45
To set the “RX MODE” function	10-45
To set the “FORWARD” function.....	10-46
To set the “FOOTER” function	10-47
To set the “SELECT TRAY” function.....	10-47

10.4 Specifying Communication Settings (“COMM.SETTING” Menu)..... 10-48

To set the “LINE MONITOR” function	10-49
--	-------

10.5 Specifying Report Output (“REPORTING” Menu)..... 10-50

To select the “REPORTING” menu.....	10-50
To set the “ACTIVITY REPORT” function	10-51
To set the “RESERV.REPORT” function	10-52
To set the “TX RESULT REPORT” function	10-52
To set the “RX RESULT REPORT” function	10-53

11 Confirmation Mode

11.1 Checking Transmission Results..... 11-1

11.2 Checking the Machine’s Counters (“MACHINE COUNTER” Menu)..... 11-1

To check the counters.....	11-2
----------------------------	------

11.3 Outputting a report/list (“PRINT REPORT” menu)..... 11-3

To output a report/list	11-3
Transmission Result Report.....	11-4
Reception Result Report.....	11-4
Activity Report.....	11-4
Queued Job List.....	11-5
Queued Job Images.....	11-5
List of One-Touch Dial Keys	11-5
List of Speed Dial Numbers	11-5
List of Programmed Keys.....	11-5
Relay Box List.....	11-6
Machine Settings List.....	11-6
Configuration Page	11-6
PCL Font List	11-6

12 Error Messages

12.1 When the Message “LOAD PAPER” Appears 12-1

To load paper into the 1st Tray	12-1
To load paper into the 2nd Tray	12-3
To load paper into the Multiple Bypass Tray.....	12-4



12.2	When the Message “TONER EMPTY” Appears	12-5
	To replace the toner bottle.....	12-5
12.3	When the Message “PAPER JAM” Appears	12-8
	To clear a paper misfeed in the main unit or 1st Tray	12-8
	To clear a paper misfeed in the Paper Feed Cabinet.....	12-12
	To clear a paper misfeed in the Multiple Bypass Tray.....	12-13
12.4	When the Message “ORIGINAL DOC.JAM” Appears	12-15
	To clear a misfeed in the Automatic Document Feeder	12-15
12.5	Main Error Messages and Their Remedies	12-18

13 Troubleshooting

13.1	When Incorrect Copies Are Produced	13-1
13.2	When Copying Is Not Performed Correctly	13-4
13.3	When Faxing Is Not Performed Correctly	13-5
	Faxes Cannot Be Sent	13-5
	Faxes Cannot Be Received.....	13-6
	Calls Cannot Be Sent	13-7

14 Appendix

14.1	Specifications	14-1
	Main Unit Di152*/Di152f/Di183*/Di183f	14-1
	Automatic Document Feeder AF-10	14-2
	Paper Feed Cabinet PF-120.....	14-3
	Shifting Unit OT-103.....	14-3
	Job Tray JS-202	14-3
	Multiple Bypass Tray MB-5.....	14-4
14.2	List of Utility/Function/Confirm Menu Commands	14-5
	Utility Menu Commands	14-5
14.3	Care of the Machine	14-9
	Cleaning	14-9
	Housing	14-9
	Original Glass	14-9
	Document Pad.....	14-9
	Control Panel.....	14-10
14.4	Function Combination Table	14-11
	Function Combination Table.....	14-11
	Function combination codes.....	14-11
14.5	Paper Size and Zoom Ratio Tables	14-12
	Copy Paper Sizes.....	14-12
	Zoom Ratios	14-13



14.6	Power Outages	14-16
14.7	Glossary	14-17
	Terms and Definitions	14-17

15 Index



1 Introduction

1.1 END USER LICENSE AGREEMENT

PLEASE READ CAREFULLY THE LICENSE AGREEMENT BELOW BEFORE INSTALLING THE SOFTWARE. INSTALLING THE SOFTWARE INDICATES YOUR ACCEPTANCE OF THE TERMS AND CONDITIONS BELOW. IF YOU DO NOT AGREE WITH THEM, YOU SHOULD PROMPTLY RETURN THE SOFTWARE UNUSED.

1. SOFTWARE

“Software” means the computer program contained in the package, together with all codes, techniques, software tools, format, design, concepts, methods and ideas associated with the computer program and all documentation related thereto.

2. LICENSE AGREEMENT

This is a license agreement for sale. Minolta owns, or has been licensed from other owners, copyrights in the Software. Except as in this Agreement, you are not granted any rights to patents, copyrights, trade names, trademarks (whether registered or unregistered), or any other rights, franchises or licenses in respect of the Software. Title to the Software and any copy made from it is retained by Minolta or such other owners.

3. LICENSE

Minolta, hereby grants to you, and you agree to accept a non-exclusive, non-transferable and limited license and you may:

- (1) install and use the Software on a single computer.
- (2) use the Software only for your own customary business or personal purpose.
- (3) make a copy of the Software for backup or installation purpose only in support of the normal and intended use of the Software.

(4) transfer possession of copies of the Software to another party by transferring a copy of this Agreement and all other documentation along with at least one complete unaltered copy of the Software, provided that (i) you must, at the same time, either transfer to such other party or destroy all your other copies of the Software. (ii) such transfer of possession terminates your license from Minolta, and (iii) such other party shall accept and be bound by these license terms by its initial use of the Software.

4. RESTRICTIONS

(1) You shall not without the written consent of Minolta:

(i) use, copy, modify, merge or transfer copies of the Software except as provided herein, (ii) reverse assemble or reverse compile the Software except as permitted by law; or (iii) sublicense, rent, lease or distribute the Software or any copy thereof.

(2) You shall not export or re-export the Software in any form under violation of export restrictions by the government of your country.

5. LIMITED WARRANTY

Minolta warrants the media on which the software is recorded to be free from defects in materials and workmanship under normal use. Warranty details and limitations for the Hardware containing the Software are described in the Statement of Limited Warranty which was supplied with the hardware. With the exception of the foregoing express warranties applicable to hardware and media only, the Software is not warranted and is provided "AS IS".

SUCH WARRANTIES ARE IN LIEU OF ALL OTHER WARRANTIES, EXPRESS OR IMPLIED, INCLUDING, BUT NOT LIMITED TO, THE IMPLIED WARRANTIES OF MERCHANTABILITY AND FITNESS FOR A PARTICULAR PURPOSE.

6. LIMITATION OF REMEDIES

IN NO EVENT WILL MINOLTA BE LIABLE FOR ANY LOST PROFITS, LOST DATA, OR ANY OTHER INCIDENTAL OR CONSEQUENTIAL DAMAGES THAT RESULT FROM USE OR INABILITY TO USE THE SOFTWARE, EVEN IF MINOLTA OR ITS AUTHORISED REMARKETERS HAVE BEEN ADVISED OF THE POSSIBILITY OF SUCH DAMAGES OR FOR ANY CLAIM BY YOU BASED ON A THIRD PARTY CLAIM.

7. TERMINATION

You may terminate your license at any time by destroying the Software and all your copies of it or as otherwise described in these terms. Minolta may terminate your license if you fail to comply with these terms. Upon such termination, you agree to destroy all your copies of the Software.

8. GOVERNING LAW

This Agreement shall be governed by the laws of the country where the delivery is made to the original customer.

9. GOVERNMENT END USERS

If you are acquiring the Software on behalf of any unit or agency of the United States Government, the following provisions apply. Use, duplication or disclosure by the Government is subject to restrictions as set forth in the Rights in Technical Data and Computer Software clause at FAR 252.227-7013, subdivision (b)(3)(ii) or sub paragraph (c)(1)(ii), as appropriate. Further use, duplication or disclosure is subject to restrictions to restricted rights software as set forth in FAR 52.227-19(c)(2).

YOU ACKNOWLEDGE THAT YOU HAVE READ THIS AGREEMENT, UNDERSTAND IT, AND AGREE TO BE BOUND BY ITS TERMS AND CONDITIONS. NEITHER PARTY SHALL BE BOUND BY ANY STATEMENT OR REPRESENTATION NOT CONTAINED IN THIS AGREEMENT. NO CHANGE IN THIS AGREEMENT IS EFFECTIVE UNLESS WRITTEN AND SIGNED BY PROPERLY AUTHORISED REPRESENTATIVES OF EACH PARTY. BY INSTALLING THIS SOFTWARE, YOU AGREE TO ACCEPT THE TERMS OF THIS AGREEMENT.

1.2 We Want You to Be a Satisfied Customer

Thank you for choosing a Minolta Di152/Di152f/Di183/Di183f.

This User Manual describes the functions, operating procedures, precautions, and basic troubleshooting for the Di152*/Di152f/Di183*/Di183f. Before using this machine, be sure to read the User Manual thoroughly in order to ensure that you use the machine efficiently. After you have gone through the manual, store it in the holder on the machine and keep it handy at all times.

Please contact your local authorized Minolta Dealer for support and technical assistance.

Note that some of the illustrations of the machine used in the User Manual may be different from what you actually see on your machine.

* The Di152/Di183 have only the optional Fax unit for Di183/Di152 FX-1 installed.

For U.S.A. Users

FCC Part 15-Radio Frequency Devices

NOTE: This equipment has been tested and found to comply with the limits for a Class A digital device, pursuant to Part 15 of the FCC Rules. These limits are designed to provide reasonable protection against harmful interference when the equipment is operated in a commercial environment. This equipment generates, uses, and can radiate radio frequency energy and, if not installed and used in accordance with the instruction manual, may cause harmful interference to radio communications.

Operation of this equipment in a residential area is likely to cause harmful interference in which case the user will be required to correct the interference at his own expense.

WARNING: The design and production of this unit conform to FCC regulations, and any changes or modifications must be registered with the FCC and are subject to FCC control. Any changes made by the purchaser or user without first contacting the manufacturer will be subject to penalty under FCC regulations.

This device complies with Part 15 of the FCC Rules. Operation is subject to the following two conditions:
(1) This device may not cause harmful interference, and (2) this device must accept any interference received, including interference that may cause undesired operation.

For Canada Users
Interference-Causing Equipment Standard (ICES-003 Issue 3)

This Class A digital apparatus complies with Canadian ICES-003.

Cet appareil numérique de la classe A est conforme à la norme NMB-003 du Canada.

1.3 Safety Information



This section contains detailed instructions on the operation and maintenance of this machine. To achieve optimum utility of this device, all operators should carefully read and follow the instructions in this manual. Please keep this manual in a handy place near the machine.

Please read the next section before using this device. It contains important information related to user safety and preventing equipment problems.

Make sure you observe all of the precautions listed in this manual.

- * Please note that some parts of the contents of this section may not correspond with the purchased product.

Warning and Precaution Symbols

 WARNING:	Ignoring this warning could cause serious injury or even death.
 CAUTION:	Ignoring this caution could cause injury or damage to property.

Meaning of Symbols



A triangle indicates a danger against which you should take precaution.



This symbol warns against possible high temperature.



A diagonal line indicates a prohibited course of action.



This symbol warns against dismantling the device.











A black circle indicates an imperative course of action.







This symbol indicates you must unplug the device.





 **WARNING**

	<ul style="list-style-type: none"> Do not modify this product: Fire, electrical shock, or breakdown could result. If the product employs a laser, the laser beam source could cause blindness. Do not attempt to remove the covers and panels which have been fixed to the product. Some products have a high-voltage part or a laser beam source inside that could cause an electrical shock or blindness.
	<ul style="list-style-type: none"> Use only the power cord supplied in the package. Failure to use this cord could result in fire or electrical shock. Use only the specified power source voltage. Failure to do so could result in fire or electrical shock. Do not use a multiple outlet adapter to connect any other appliances or machines. Use of a power outlet for more than the marked current value could result in fire or electrical shock.
	<p>Do not unplug and plug in the power cord with a wet hand: An electrical shock could result.</p>
	<p>Plug the power cord all the way into the power outlet. Failure to do so could result in fire or electrical shock.</p>
	<ul style="list-style-type: none"> Do not scratch, abrade, place a heavy object on, heat, twist, bend, pull on, or damage the power cord. Use of a damaged power cord (exposed core wire, broken wire, etc.) could result in fire or breakdown. Should any of these conditions be found, immediately turn OFF the power switch, unplug the power cord from the power outlet, and then call your authorized service representative. In principle, do not use an extension cord. Use of an extension cord could cause fire or electrical shock. Contact your authorized service representative if an extension cord is required.
	<p>Do not place a flower vase or other container that contains water, or metal clips or other small metallic objects on this product. Spilled water or metallic objects dropped inside the product could result in fire, electrical shock, or break-down.</p> <p>Should a piece of metal, water, or any other similar foreign matter get inside the product, immediately turn OFF the power switch, unplug the power cord from the power outlet, and then call your authorized service representative.</p>
	<ul style="list-style-type: none"> If this product becomes inordinately hot or emits smoke, or emits an unusual odor or noise, immediately turn OFF the power switch, unplug the power cord from the power outlet, and then call your authorized service representative. If you keep on using it as is, fire or electrical shock could result. If this product has been dropped or its cover damaged, immediately turn OFF the power switch, unplug the power cord from the power outlet, and then call your authorized service representative. If you keep on using it as is, fire or electrical shock could result.
	<p>Do not throw the toner cartridge or toner into an open flame. The hot toner may scatter and cause burns or other damage.</p>
	<p>Connect the power cord only to an electrical outlet that is equipped with a grounding terminal.</p>

 **CAUTION**

	<ul style="list-style-type: none"> • Do not use flammable sprays, liquids, or gases near this product, as fire could result. • Do not leave a toner unit or drum unit in a place within easy reach of children. Licking or ingesting any of these substances could injure your health. • Do not let any object plug the ventilation holes of this product. Heat could accumulate inside the product, resulting in a fire or malfunction. • Do not install this product at a site that is exposed to direct sunlight, or near an air conditioner or heating apparatus. The resultant temperature changes inside the product could cause a malfunction, fire, or electrical shock. • Do not place the product in a dusty place, or a site exposed to soot or steam, near a kitchen table, bath, or a humidifier. Fire, electrical shock, or breakdown could result. • Do not place this product on an unstable or tilted bench, or in a location subject to a lot of vibration and shock. It could drop or fall, causing personal injury or mechanical breakdown. • After installing this product, mount it on a secure base. If the unit moves or falls, it may cause personal injury. • Do not store toner units and PC drum units near a floppy disk or watch that are susceptible to magnetism. They could cause these products to malfunction.
	<p>The inside of this product has areas subject to high temperature, which may cause burns. When checking the inside of the unit for malfunctions such as a paper misfeed, do not touch the locations (around the fusing unit, etc.) which are indicated by a "Caution! High Temperature!" warning label.</p>
	<p>Do not place any objects around the power plug, as the power plug may be difficult to pull out when an emergency occurs.</p>
	<ul style="list-style-type: none"> • Always use this product in a well ventilated location. Operating the product in a poorly ventilated room for an extended period of time could injure your health. Ventilate the room at regular intervals. • Whenever moving this product, be sure to disconnect the power cord and other cables. Failure to do this could damage the cord or cable, resulting in fire, electrical shock, or breakdown. • When moving this product, always hold it by the locations specified in the User manual or other documents. If the unit falls it may cause severe personal injury. The product may also be damaged or malfunction. • Remove the power plug from the outlet at least twice a year and clean the area between the plug terminals. Dust that accumulates between the plug terminals could cause a fire. • When unplugging the power cord, be sure to hold onto the plug. Pulling on the power cord could damage the cord, resulting in fire or electrical shock.

Precautions for Routine Use

	<ul style="list-style-type: none">• Do not store toner units, PC drum units, or other supplies and consumables in a place subject to direct sunlight and high temperature or humidity, as poor image quality and malfunction could result.• Do not attempt to replace the toner unit and PC drum unit in a place exposed to direct sunlight. If the PC drum is exposed to intense light, poor image quality could result.• Do not unpack a toner unit or PC drum unit until the very time of use. Do not leave an unpacked unit standing. Install it immediately or poor image quality could result.• Do not keep toner units and PC drum units in an upright position or upside down, as poor image quality could result.• Do not throw or drop a toner unit or PC drum unit, as poor image quality could result.• Do not use this product in an area where ammonia or other gases or chemicals are present. Failure to do so may shorten the service life of the product, cause damage or decrease performance.• Do not use this product in an environment with a temperature outside the range specified in the User manual, as breakdown or malfunction could result.• Do not attempt to feed stapled paper, carbon paper or aluminum foil through this product, as malfunction or fire could result.
	<p>Do not touch or scratch the surface of the toner unit developing roller or the PC drum, as poor image quality could result.</p>
	<p>Use the supplies and consumables recommended by the dealer. Use of any supply or consumable not recommended could result in poor image quality or breakdown.</p>
	<ul style="list-style-type: none">• Do not rest your weight on the control panel, as a malfunction could result.• Normal international communications may at times not be possible depending on line conditions.• If tap or well water is used in a humidifier, impurities in the water are discharged into the air and may be deposited inside the printer, resulting in poor image quality. It is recommended that pure water that does not contain any impurities be used in the humidifier.• The cooling fan may be activated automatically, but this suggests no problems.• Ni-MH (Nickel Metal Hydride) Batteries are installed inside machine as back up memory batteries. Please dispose according to local, state and federal regulations.

FCC Part 68 – Telecommunication Devices

This equipment complies with Part 68 of the FCC rules. On the rear panel of this equipment is a label that contains, among other information, the FCC registration number and Ringer Equivalence Number (REN) for this equipment. If requested, provide this information to your telephone company.

This equipment uses THE FOLLOWING USOC JACKS: RJ11C.

The REN is useful to determine the quantity of devices you may connect to your telephone line and still have all of those devices ring when your number is called. In most, but not all areas, the sum of the RENs of all devices should not exceed five (5.0). To be certain of the number of devices you may connect to your line, as determined by the REN, you should call your local telephone company to determine the maximum REN for your calling area.

If your telephone equipment causes harm to the telephone network, the Telephone Company may discontinue your service temporarily. If possible, they will notify you in advance. But if advance notice isn't practical, you will be notified as soon as possible. You will be advised of your right to file a complaint with the FCC.

Your telephone company may make changes to its facilities, equipment, operations, or procedures that could affect the proper operation of your equipment. If they do, you will be given advance notice so as to give you an opportunity to maintain uninterrupted service.

If you experience trouble with this equipment, please contact:

**Minolta Corporation
101 Williams Drive Ramsey.
New Jersey 07446
U.S.A.**

The telephone company may ask you to disconnect this equipment from the network until the problem has been corrected or you are sure that the equipment is not malfunctioning.

This equipment may not be used on coin service provided by the telephone company. Connection to party lines is subject to state tariffs. (Contact your state public utility commission or corporation commission for information.)

Customer Information For Privately Owned Coin Phones

To comply with state tariffs, the telephone company must be given notification prior to connection.

In some states, prior approval of connection must be obtained from the state Public Utility Commission, Public Service Commission or state Corporation Commission.

Warning For The Setting Of Header And Footer

The Telephone Consumer Protection Act of 1991 makes it unlawful for any person to use a computer or other electronic device to send any message via a telephone fax machine unless such message clearly contains in a margin at the top or bottom of each transmitted page or on the first page of the transmission, the date and time it is sent and an identification of the business or other entity, or other individual sending the message and the telephone number of the sending machine or such business, other entity, or individual.

In order to program this information into your fax machine, you should complete the following steps. (Refer to p. 3-32 and p. 3-33.)

IC CS-03-Telecommunication Devices

NOTICE:

Industry Canada (IC) label identifies certified equipment. This certification means that the equipment meets certain telecommunications network protective, operational, and safety requirements. IC does not guarantee the equipment will operate to the user's satisfaction.

Before installing this equipment, users should ensure that it is permissible to be connected to the facilities of the local telecommunications company. The equipment must also be installed using an acceptable method of connection. In some cases, the company's inside wiring associated with a single line individual service may be extended by means of a certified connector assembly (telephone extension cord). The customer should be aware that compliance with the above conditions may not prevent degradation of service in some situations.

Repairs to certified equipment should be made by an authorized Canadian maintenance facility designated by the supplier. Any repairs or alterations made by the user to this equipment, or equipment malfunctions, may give the telecommunications company cause to request the user to disconnect the equipment.

Users should ensure for their own protection that the electrical ground connections of the power utility, telephone lines, and internal metallic water pipe system, if present, are connected together. This precaution may be particularly important in rural areas.

CAUTION:

Users should not attempt to make such connections themselves, but should contact the appropriate electric inspection authority, or electrician, as appropriate.

NOTICE:

The **Ringer Equivalence Number (REN)** assigned to each terminal device provides an indication of the maximum number of terminals allowed to be connected to a telephone interface. The termination on an interface may consist of any combination of devices subject only to the requirement that the sum of the Ringer Equivalence Numbers of all the devices does not exceed 5. REN = 0.2

If you experience trouble with this equipment, please contact:

Minolta Business Equipment (Canada), Ltd.
369 Britannia Road E.
Mississauga, Ontario L42 2H5
Tel: (905) 890-6600

Laser Safety

This is a digital machine which operates using a laser. There is no possibility of danger from the laser provided the machine is operated according to the instructions in this manual.

Since radiation emitted by the laser is completely confined within protective housing, the laser beam cannot escape from the machine during any phase of user operation.

This machine is certified as a Class 1 laser product: This means the machine does not produce hazardous laser radiation.

Internal Laser Radiation

Maximum Average Radiation Power: 26.4 μ W at the laser aperture of the print head unit.

Wavelength: 770-795 nm

This product employs a Class 3b laser diode that emits an invisible laser beam.

The laser diode and the scanning polygon mirror are incorporated in the print head unit.

The print head unit is NOT A FIELD SERVICE ITEM:

Therefore, the print head unit should not be opened under any circumstances.

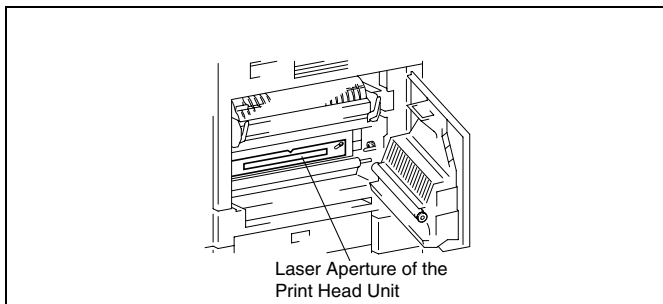
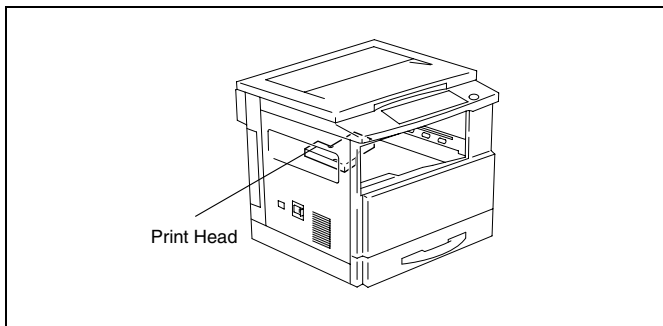

There is a laser aperture at the location shown above, which must, however, NEVER be viewed directly by the user.

CDRH Regulation

This machine is certified as a Class 1 Laser product under Radiation Performance Standard according to the Food, Drug and Cosmetic Act of 1990. Compliance is mandatory for Laser products marketed in the United States and is reported to the Center for Devices and Radiological Health (CDRH) of the U.S. Food and Drug Administration of the U.S. Department of Health and Human Services (DHHS). This means that the device does not produce hazardous laser radiation.

The label shown on page 1-14 indicates compliance with the CDRH regulations and must be attached to laser products marketed in the United States.

CAUTION

Use of controls, adjustments or performance of procedures other than those specified in this manual may result in hazardous radiation exposure.

This is a semiconductor laser. The maximum power of the laser diode is 5 mW and the wavelength is 770-795 nm.

Laser Safety Label

A laser safety label is attached to the outside of the machine as shown below.

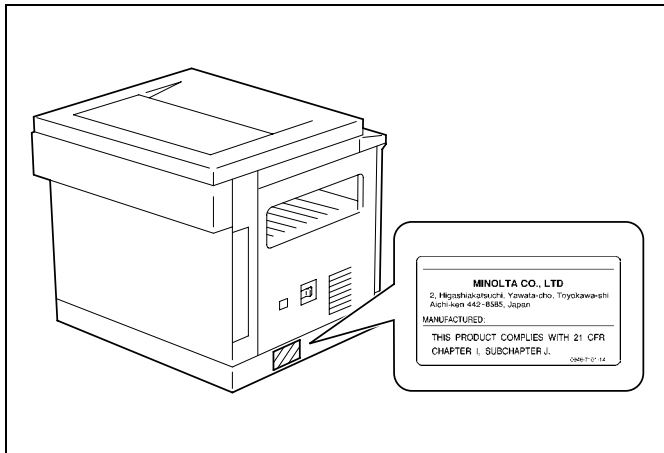
**Ozone Release**

NOTE

= Locate the Machine in a Well Ventilated Room =

A negligible amount of ozone is generated during normal operation of this machine. An unpleasant odor may, however, be created in poorly ventilated rooms during extensive machine operations. For a comfortable, healthy, and safe operating environment, it is recommended that the room well ventilated.

REMARQUE

= Placer l'appareil dans une pièce largement ventilée =
Une quantité d'ozone négligable est dégagée pendant le fonctionnement de l'appareil quand celui-ci est utilisé normalement. Cependant, une odeur désagréable peut être ressentie dans les pièces dont l'aération est insuffisante et lorsque une utilisation prolongée de l'appareil est effectuée. Pour avoir la certitude de travailler dans un environnement réunissant des conditions de confort, santé et de sécurité, il est préférable de bien aérer la pièce où se trouve l'appareil.

Notice for Ni-MH Batteries

Ni-MH (Nickel Metal Hydride) Batteries are installed inside machine as back up memory batteries. Please dispose according to local, state and federal regulations.

1.4 About the User Manual

Explanation of Manual Conventions

The marks and text formats used in this manual are described below.



WARNING

Failure to observe instructions highlighted in this manner may result in fatal or critical injuries.

→ Observe all warnings in order to ensure safe use of the machine.



CAUTION

Failure to observe instructions highlighted in this manner may result in serious injuries or property damage.

→ Observe all cautions in order to ensure safe use of the machine.



Note

(* May also appear as "Important" or "Tip")

Text highlighted in this manner contains useful information and tips to ensure safe use of the machine and serve as supplementary information. It is recommended that you read all of them.

- 1** The number 1 as formatted here indicates the first step of a sequence of actions.
- 2** Subsequent numbers as formatted here indicate subsequent steps of a sequence of actions.

? *Text formatted in this style provides additional assistance.*

→ Text formatted in this style describes the action that will ensure the desired results are achieved.

An illustration inserted here shows what operations must be performed.

[] key

The names of keys on the Control Panel are written as shown above.

1.5 Explanation of Basic Concepts and Symbols

The use of words and symbols in this manual are explained below.

Paper Feeding

During printing, paper is supplied from the right side of the machine and fed into the Exit Tray on top with the printed surface of the page facing down. The paper feed direction is shown by the arrows in the diagram below.

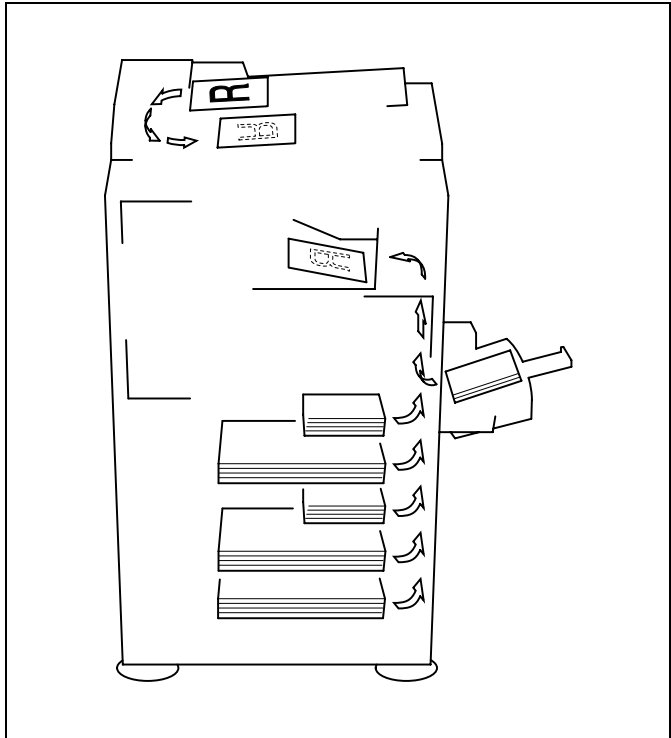

“Width” and “Length”

Whenever paper dimensions are mentioned in this manual, the first value always refers to the width of the paper (shown as “A” in the illustration) and the second to the length (shown as “B”).

A: Width

B: Length

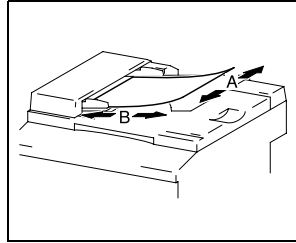



Paper Orientation

Lengthwise ()

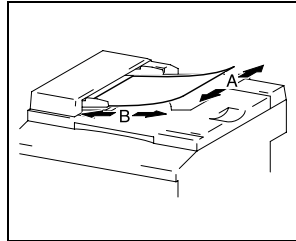
If the width (A) of the paper is shorter than the length (B), the paper has a vertical or portrait orientation, indicated by either “L” or .



Crosswise ()

If the width (A) of the paper is longer than the length (B), the paper has a horizontal or landscape orientation, indicated by either “C” or .

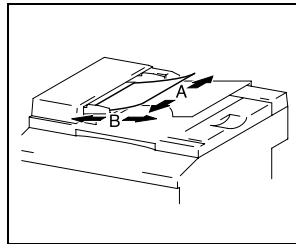

2 Precautions

Observe the following precautions to keep the machine in the best possible conditions.

2.1 Installation Precautions

Installation site

To ensure utmost safety and prevent possible malfunctions, install the machine in a location that meets the following requirements:

- A location away from curtains, etc. that may catch fire and burn easily
- A location that is not exposed to water or other liquids
- A location free from direct sunlight
- A location out of the direct airflow of an air conditioner or heater, and not exposed to extremely high or low temperatures
- A well-ventilated location
- A location that is not exposed to high humidity
- A location that is not extremely dusty
- A location not subjected to undue vibrations
- A stable and level location
- A location where ammonia or other organic gases are not generated
- A location that does not put the operator in the direct airflow of exhaust from the machine
- A location that is not near any kind of heating devices

Power source

The power source requirements are as follows.

- Voltage Fluctuation: Within $\pm 10\%$ (127 V: +6%, -10%)
- Frequency Fluctuation: Within ± 3 Hz
- Use a power source with as few voltage or frequency fluctuations as possible.

Space Requirements

To ensure easy machine operation, supply replacement, and maintenance, adhere to the recommended space requirements detailed below.

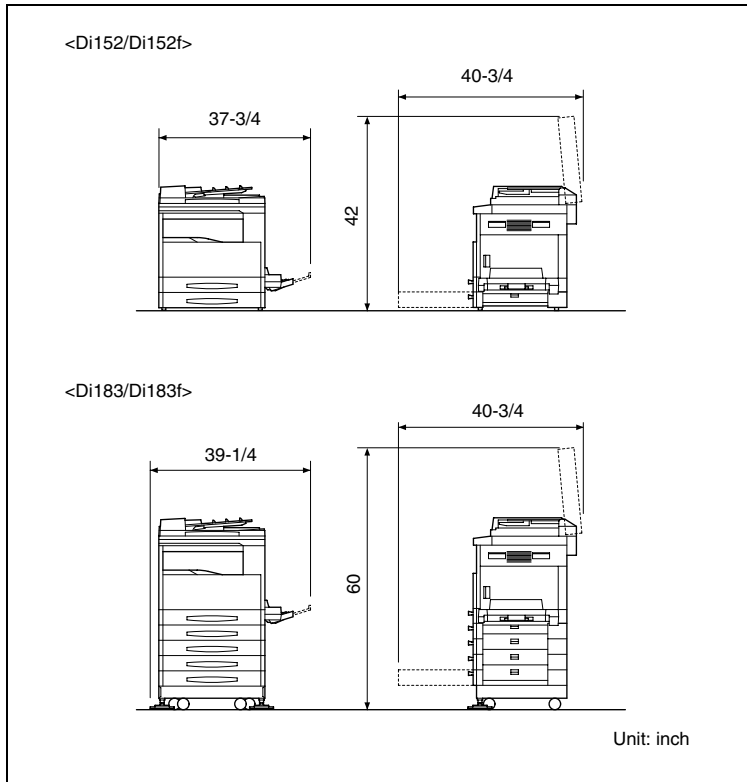

Note

Be sure to allow a clearance of 4 inch or more at the back of the machine, and 6 inch or more at the right of the machine for the removal of misfed papers.

2.2 Operation Precautions

Operating Environment

The environmental requirements for correct operation of the machine are as follows:

- Temperature: 50°F to 90°F (10°C to 30°C) with fluctuations of no more than 18°F (10°C) within an hour
- Humidity: 15% to 85% with fluctuations of no more than 10% within an hour

Proper Use

To ensure the optimum performance of the machine, follow the precautions listed below:

- Never place heavy objects on the Original Glass or subject it to shocks.
- Never open any machine doors or turn OFF the machine while it is making copies/printing, as a paper misfeed could result.
- Never bring any magnetized object, or use flammable sprays or liquids, near the machine.
- ✦ Always make sure that the power plug is completely plugged into the electrical output.
- Always make sure that the machine's power plug is visible and not hidden by the machine.
- ✦ Always unplug the machine from the electrical outlet if the machine is not to be used for a long period of time.
- ✦ Always provide good ventilation when making a large number of continuous copies/printed pages.



CAUTION

A negligible amount of ozone is generated during normal operation of this machine. An unpleasant odor may, however, be detected in poorly ventilated rooms during extensive machine operations.

- For a comfortable operating environment, it is recommended that the room be well ventilated.
-



CAUTION**The area around the Fusing Unit is extremely hot.**

- Do not touch any area other than those authorized in the manual to reduce the risk of burns. Be especially careful not to touch parts marked with warning labels, and their surrounding areas.
 - If you get burnt, immediately cool the skin under cold water, and then seek professional medical advice.
-

Transporting the Machine

If you need to transport the machine over a long distance, consult your Tech. Rep.

Care of Machine Supplies

Use the following precautions when handling the machine supplies (toner, paper, etc.).

- + Store the supplies in a location that meets the following requirements:
 - Free from direct sunlight
 - Away from any heating apparatus
 - Not subjected to high humidity
 - Not extremely dusty
- + Paper that has been removed from its wrapper but not loaded in the machine should be stored in a sealed plastic bag in a cool, dark place.
- Use only toner that has been manufactured specifically for this machine. Never use other types of toner.
- Keep all supplies out of the reach of children.



CAUTION**Be careful not to spill toner inside the machine or get toner on your clothes or hands.**

- If your hands become soiled with toner, immediately wash them with soap and water.
 - If toner gets in your eyes, immediately flush them with water, and then seek professional medical advice.
-

2.3 Legal Restrictions on Copying

Certain types of documents must not be copied with the purpose or intent to pass copies of such documents off as the originals.

The following is not a complete list, but is meant to be used as a guide to responsible copying.

<Financial Instruments>

- Personal checks
- Travelers checks
- Money orders
- Certificates of deposit
- Bonds or other certificates of indebtedness
- Stock certificates

<Legal Documents>

- Food stamps
- Postage stamps (canceled or uncanceled)
- Checks or drafts drawn by government agencies
- Internal revenue stamps (canceled or uncanceled)
- Passports
- Immigration papers
- Motor vehicle licenses and titles
- House and property titles and deeds

<General>

- Identification cards, badges, or insignias
- Copyrighted works without permission of the copyright owner

In addition, it is prohibited under any circumstances to copy domestic or foreign currencies, or works of art, without permission of the copyright owner.

When in doubt about the nature of a document, consult with legal counsel.

3 Before Making Copies or Faxing

3.1 Available Copy Features

The main copy functions available with this machine are listed below. For details on their operation, refer to the pages indicated.

Copying (p. 4-1)

- Single-sided copies

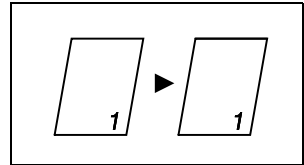

- "2in1" copy function

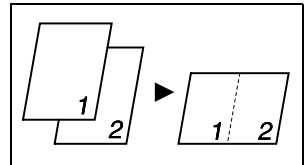

- "4in1" copy function

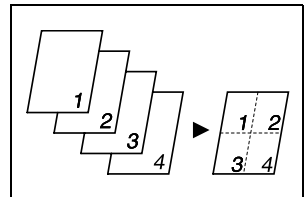

- "Book Separation" function

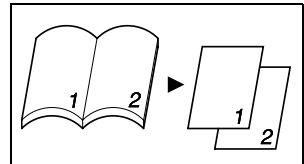

“Zoom” function (p. 4-21)

- Reduced/full-sized/enlarged

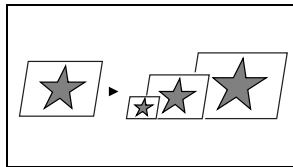

- “X/Y Zoom” function (p. 4-23)

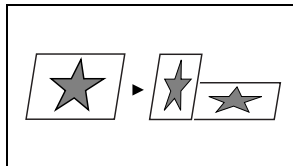

Finishing (p. 5-5)

- “Sort” function

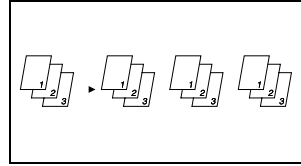

- “Group” function

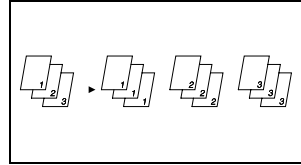

- Crisscross output (sorting)

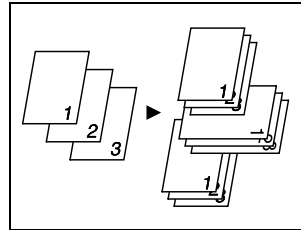

- Crisscross output (grouping)

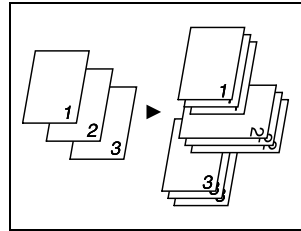

Note

The required options differ depending on the desired copy function.

Special features

- “Erase” function (p. 5-9)

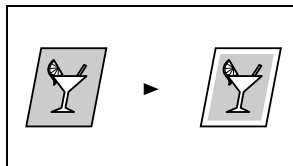

- Negative/positive-inverted copy function (p. 5-12)



- “File Margin” function (p. 5-13)

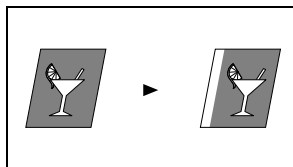

“Mixed Orig.” function (p. 4-2)

- Mixed originals

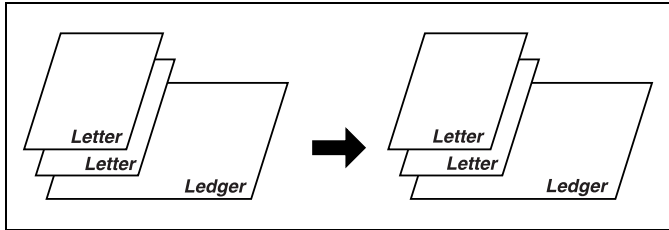

Note

The “Mixed Orig.” function is only available when an Automatic Document Feeder (optional) is installed.

3.2 Available Fax Features

Sending

- Broadcast transmission (p. 7-4)

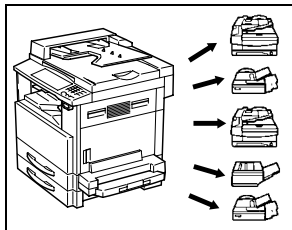

- Timer transmission (p. 7-7)

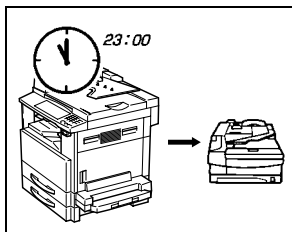

- Relay initiation transmission (p. 7-11)

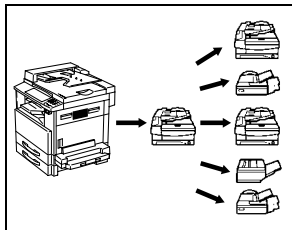

- Polling transmission (p. 7-16)

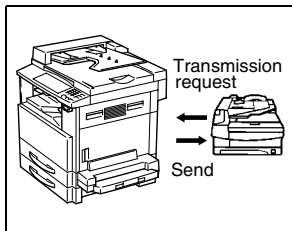

Receiving

- Memory reception (p. 7-21)

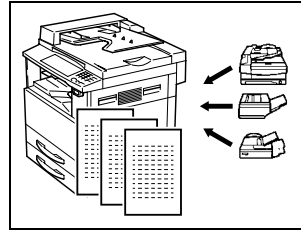

- Polling reception (p. 7-23)

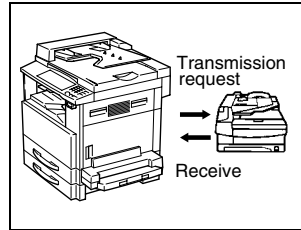

- Mailbox reception (p. 7-22)

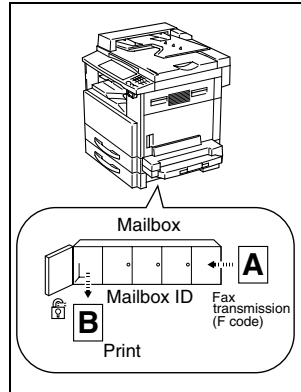

- Forwarding (p. 10-46)

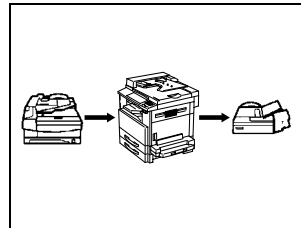

3.3 Components and Their Functions

Each of the components of the machine as well as their functions are described below.

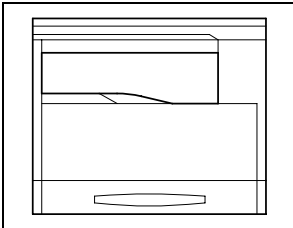
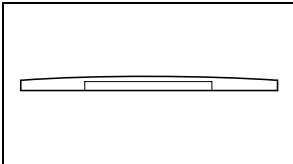
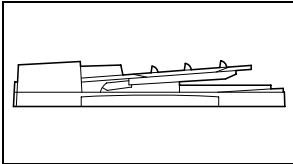
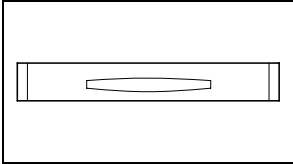
- Main unit Di152/Di152f/Di183/Di183f
 
- Original Cover Kit OC-5 (optional)
Presses down on the document positioned on the Original Glass.
 
- Automatic Document Feeder AF-10 (optional)
Automatically feeds one document page at a time for scanning.
 
- Paper Feed Cabinet PF-120 (optional)
Includes a paper tray that can be loaded with up to 250 sheets of copy paper. (With the Di152f, one can be installed; with the Di183f, up to four can be installed.)
 
- Shifting Unit OT-103 (optional)
Sorts or groups pages according to the specified Finishing function.
- Job Tray JS-202 (optional)
Separates received faxes, printouts and copies between and collects them in the upper and lower trays.

- **Multiple Bypass MB-5 (optional)**
Allows a maximum of 50 sheets of paper to be supplied through the Bypass Tray.

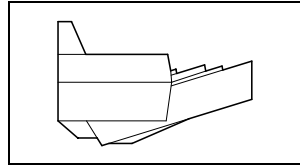

- **Copy Desk PF-11T (optional)**
Adjusts the height of the machine after Paper Feed Cabinets have been installed (Use when only one or no Paper Feed Cabinets are installed.)

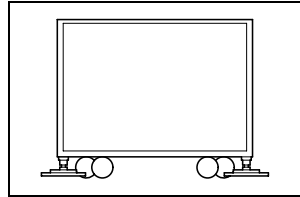

- **Copy Desk CD-3M (optional)**
Adjusts the height of the machine after Paper Feed Cabinets have been installed (Use when only one or no Paper Feed Cabinets are installed.)

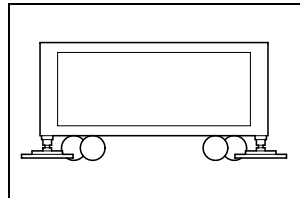

- **Copy Table CT-3 (optional)**
Adjusts the height of the machine after Paper Feed Cabinets have been installed (Use when only one or no Paper Feed Cabinets are installed.)

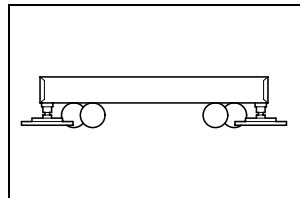

- **Printer Controller Pi1802e (optional)**
Internal printer controller that allows this machine to be connected to a computer and used as a printer.
- **Network Interface Card NC-3 (optional)**
Allows this machine to be used as a printer over a network.
- **Internet Fax & Network scan kit SU-1 (optional)**
Allows scanned images to be sent to a computer or Internet fax via an Internet mail server, and enables e-mail to be received.
- **32MB Memory for Copier M32-3 (optional for Di152/Di183)**
Increases (32 MB) the copier memory.
- **8MB Memory for Fax M8-2 (optional for Di152f/Di183f)**
Increases (8 MB) the fax memory. This allows more sent and received faxes to be stored.

3.4 Part Names and Their Functions

Main Unit

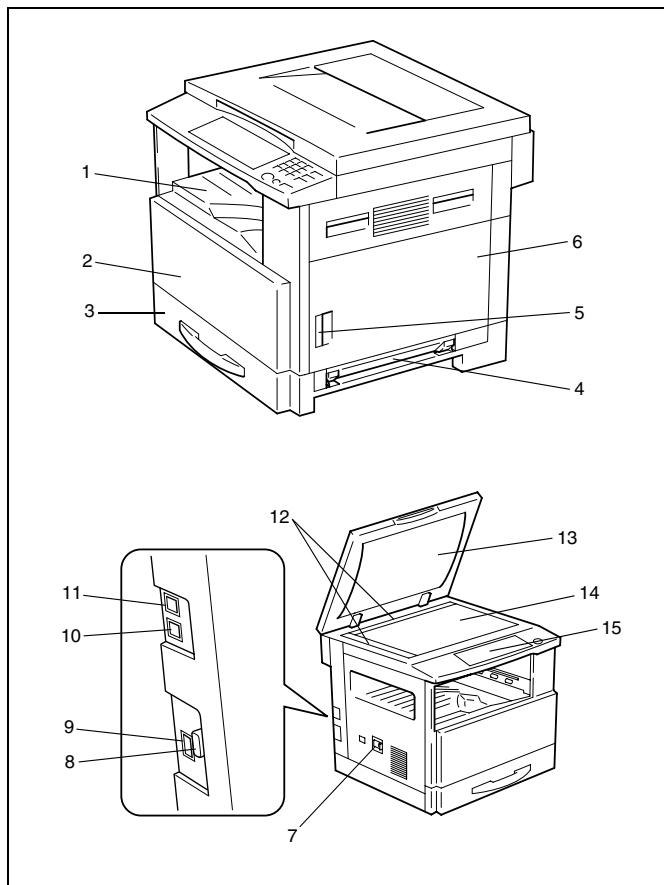

*The illustration above shows the optional Original Cover Kit installed.

No.	Part Name	Description
1	Copy Tray	Collects fed-out copies facing down.
2	Front Cover	Opened when replacing the toner bottle. (p. 12-5)
3	1st Tray	<ul style="list-style-type: none"> • Holds up to 250 sheets of paper. • The paper size can be adjusted freely. • Can be loaded with special paper. (p. 3-39)
4	Manual Bypass Tray	<ul style="list-style-type: none"> • Used for manual feeding of paper. • The paper is fed one sheet at a time. • Can be loaded with special paper. (p. 3-39)
5	Lock Release Lever	Used to open and close the Side Cover.
6	Side Cover	Opened when clearing paper misfeeds.
7	Power Switch	Used to turn the machine on and off. (p. 3-28)
8	Serial Interface Connector	Used for connecting the RS232C interface cable when this machine is used for PC faxing and PC scanning.
9	Network Interface Connector	Used for connecting the network cable when this machine is used for Internet faxing and network scanning.
10	External Telephone Connector (TEL)	Used for connecting the cord from the telephone.
11	Telephone Line Connector (LINE)	Used for connecting the telephone cord from the wall jack.
12	Document Scales	Used to align the document. (p. 4-5)
13	Original Cover (optional)	Presses down on the document positioned on the Original Glass.
14	Original Glass	When manually feeding a document, position it on the Original Glass so that it can be scanned. Position the document face down on the glass. (p. 4-5)
15	Control Panel	Used to start copying or to make various settings. (p. 3-18)

Inside of Main Unit

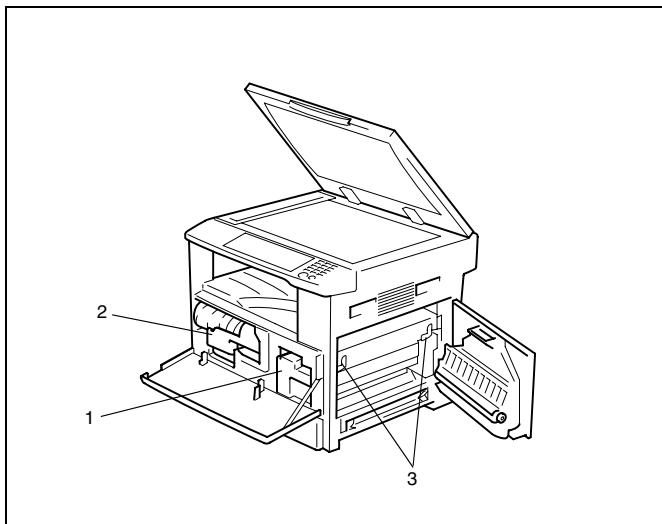

No.	Part Name	Description
1	Imaging Unit	Creates the copy image. Replacement of the Imaging Unit must be performed by a service representative.
2	Toner Bottle Holder	Opened when replacing the toner bottle.
3	Pressure Lever	Used when clearing paper misfeeds in the fusing unit. (p. 12-8)

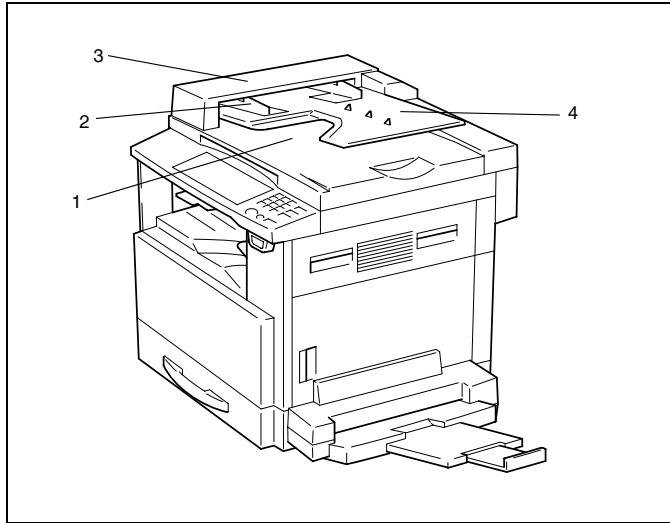
Automatic Document Feeder (Optional)

No.	Part Name	Description
1	Document Exit Tray	Collects documents that have been scanned.
2	Document Guide Plate	Adjusted to the size of the document. (p. 4-1)
3	Document Feeder Cover (Doc. Feed Cover)	Opened when clearing document misfeeds. (p. 12-8)
4	Document Feeder Tray	Holds the documents to be scanned; load documents face up. (p. 4-1)

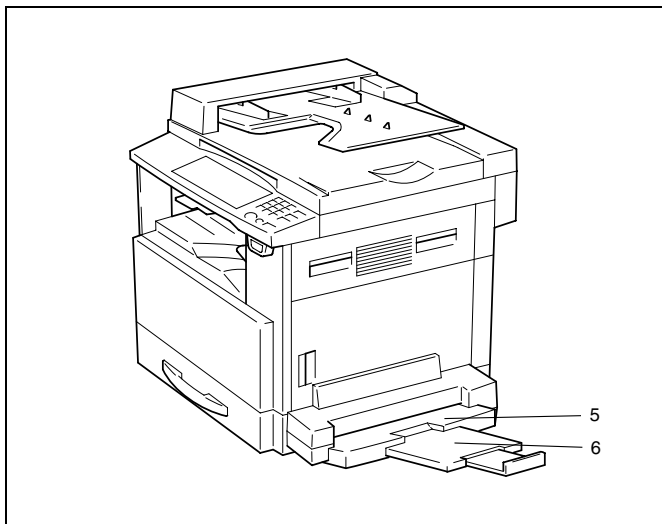
Multiple Bypass Tray (Optional)

No.	Part Name	Description
5	Bypass Tray	Holds up to 50 sheets (plain paper) or 20 sheets (special paper) of paper. (p. 4-17)
6	Bypass Tray Extender	Pulled out when large-sized paper is loaded.

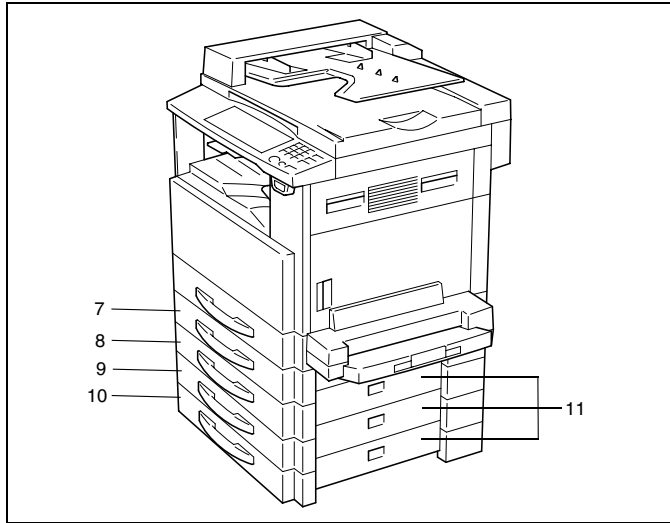
Paper Feed Cabinet (Optional)

No.	Part Name	Description
7	2nd Tray	Holds up to 250 sheets of paper (plain paper). With the Di183/Di183f, up to four Paper Feed Cabinets can be installed. With the Di152/Di152f, one Paper Feed Cabinet can be installed.
8	3rd Tray	
9	4th Tray	
10	5th Tray	
11	Side Cover	Opened when clearing paper misfeeds. (p. 12-12)

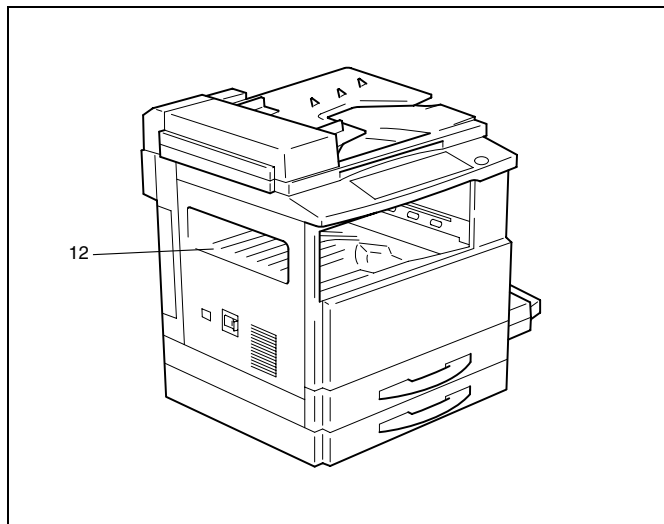
Shifting Unit (Optional)

No.	Part Name	Description
12	Copy Tray	Collects fed-out copies that have been sorted.

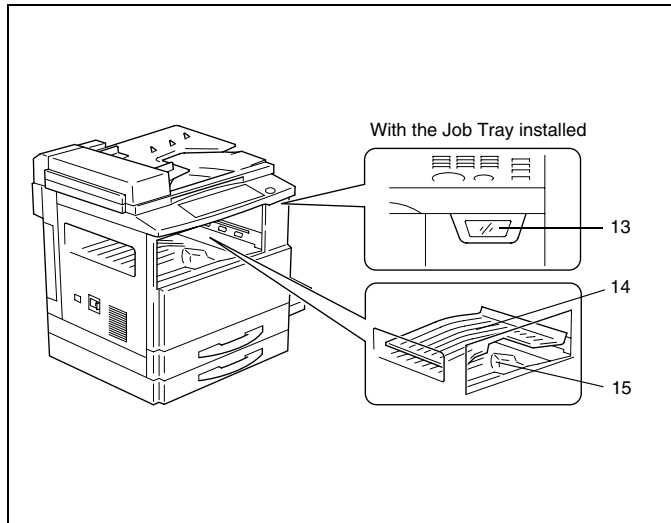
Job Tray (Optional)

No.	Part Name	Description
13	Copy Tray Lamp	Lights up when paper is fed into the Upper Copy Tray.
14	Upper Copy Tray	Collects computer printouts or received faxes.
15	Lower Copy Tray	Collects copies.

3.5 Names of Control Panel Parts and Their Functions

Control Panel Parts and Their Functions

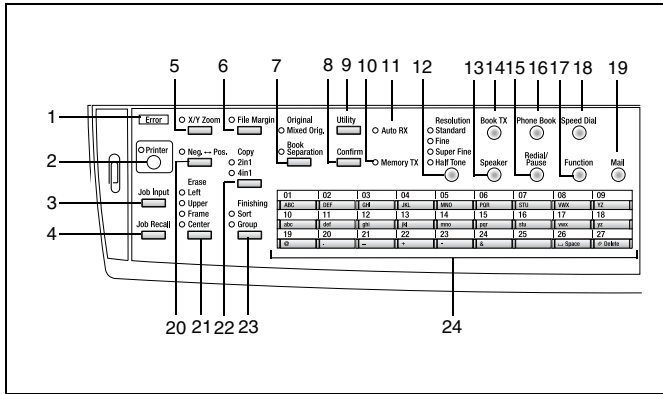

No.	Part Name	Function
1	"Error" indicator	Lights up when an error has occurred. Refer to "Error Messages" on page 12-1.
2	[Printer] key/indicator	Lights up while data is being printed from the computer and flashes while data is being sent. For details, refer to the User Manual for the Printer Controller.
3	[Job Input] key	Used to store the current copy settings (Up to two copy programs can be stored).
4	[Job Recall] key	Used to recall a stored copy program.
5	[X/Y Zoom] key	Used to specify different scaling proportions for the vertical and horizontal directions.
6	[File Margin] key	Press to select the "File Margin" function.
7	[Original] key	Used to select between the "Mixed Orig." function and the "Book Separation" function.
8	[Confirm] key	Used to view the transmission results or the counters, or to print a transmission result report.
9	[Utility] key	Used to enter Utility mode and display the first Utility mode screen. <ul style="list-style-type: none"> MACHINE SETTING, PAPER SOURCE SETTING, USER MAINTENANCE, ADMIN. MANAGEMENT, COPY SETTING 1 & 2, FAX REGISTRATION, TX OPERATION, RX OPERATION, COM.SETTING, REPORTING, INITIAL USER DATA Refer to "Utility Mode – Fax Functions" on page 10-1.

No.	Part Name	Function
10	"Memory TX" indicator	Lights up when the memory transmission function is selected.
11	"Auto RX" indicator	Lights up when the automatic reception function is selected.
12	[Resolution] key	Used to select the image quality (transmission resolution).
13	[Speaker] key	Press to answer the call. Press again to hang up.
14	[Book TX] key	Press when transmitting a document positioned on the Original Glass.
15	[Redial/Pause] key	<ul style="list-style-type: none"> Redials the last number called. While dialing, used to generate a pause when transferring from an internal to an external line or receiving information services.
16	[Phone Book] key	Used to display the information programmed for one-touch dialing, group dialing and speed dialing.
17	[Function] key	<p>Used to select a function.</p> <ul style="list-style-type: none"> BROADCAST (broadcast transmission), TIMER TX (timer transmission), MAILBOX TX (mailbox transmission), PRINT MAILBOX RX (retrieve mailbox faxes), POLLING TX (polling transmission) POLLING RX (polling reception), RELAY INITIATE (relay initiation transmission), CANCEL RESERV. (cancel queued job), TX MODE (transmission mode), Internet fax reception (with the Internet Fax & Network scan kit installed) <p>Refer to "Fax Transmission/Reception Methods" on page 7-1.</p>
18	[Speed Dial] key	Used to dial previously programmed fax numbers represented by 3-digit numbers.
19	[Mail] key	<p>Press to enter Mail Address mode. The indicator lights up in green to indicate that an e-mail address can be entered.</p> <p>(Available only when the Internet Fax & Network scan kit is installed.)</p>
20	[Neg. ↔ Pos.] key	Press to make copies with the dark- and light-colored areas of the document inverted.
21	[Erase] key	Used to select the area of the document that is erased.
22	[Copy] key	Used to select between the "2in1" and the "4in1" copy functions.
23	[Finishing] key	Used to select a copy Finishing function.
24	One-touch dial keys	<ul style="list-style-type: none"> Used to dial previously programmed fax numbers. Used to enter text such as a name.

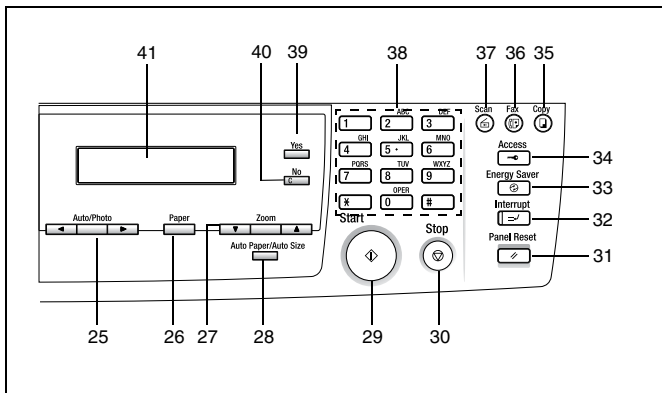

No.	Part Name	Function
25	[Auto/Photo] key, ◀ and ▶ keys	<ul style="list-style-type: none"> Used to specify the scanning density of copies. Used to specify the selection at the left or right in setting screens.
26	[Paper] key	Used to select the size of the paper to be printed on.
27	[Zoom] key, ▲ and ▼ keys	<ul style="list-style-type: none"> Used to select a preset enlargement or reduction ratio. With each press, a zoom ratio between $\times 0.50$ and $\times 2.00$ in 0.01 increments is selected. Used to specify the selection above or below in setting screens and menus.
28	[Auto Paper/Auto Size] key	Used to select between the "Auto Paper" or the "Auto Size" function.
29	[Start] key	<ul style="list-style-type: none"> Starts copying. Starts a fax transmission. Queues a copy job if pressed while the machine is warming up. (p. 3-25) The indicator lights up in green to indicate that the machine is ready to start copying or it lights up in orange to indicate that the machine is not ready to start copying.
30	[Stop] key	<ul style="list-style-type: none"> Stops the multi-page copy operation. Stops the fax transmission or reception.
31	[Panel Reset] key	<ul style="list-style-type: none"> Cancels all copy functions and returns them to their default settings (Deletes all queued jobs). (p. 3-24) Cancels all fax functions and returns them to their default settings. <p>*Queued timer transmission faxes and documents received during memory reception are not cancelled.</p>
32	[Interrupt] key	Press to enter Interrupt mode. The indicator lights up in green to indicate that the machine is in Interrupt mode. Press again to cancel Interrupt mode and return to the mode before Interrupt mode was entered. (p. 3-26)

No.	Part Name	Function
33	[Energy Saver] key	Press to enter Energy Saver mode. (p. 3-25)
34	[Access] key	Used with user management. (p. 3-26)
35	[Copy] key	Press to enter Copy mode. The indicator lights up in green to indicate that the machine is in Copy mode.
36	[Fax] key	Press to enter Fax mode. The indicator lights up in green to indicate that the machine is in Fax mode.
37	[Scan] key	Press to enter Scan mode. The indicator lights up in green to indicate that the machine is in Scan mode. (Available only when the Internet Fax & Network scan kit is installed.)
38	10-Key Pad	<ul style="list-style-type: none">• Used to specify the number of copies.• Used to enter setting values.• Used to enter fax numbers.• Used to enter speed dial numbers.
39	[Yes] key	Confirms the current setting.
40	[No] key	Erases the entered numbers and letters. Returns to the previous screen.
41	Display	Displays setting menus, error messages, and specified settings such as the number of copies, the zoom ratio and fax numbers.

Display Indications

In Copy mode:

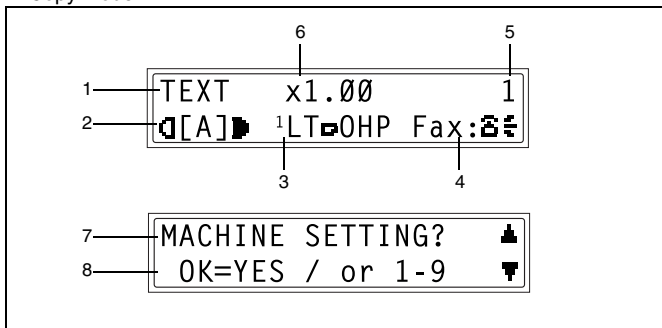

No.	Display Indication	Description
1	Copy density (document type)	Indicates the document type for the copy density setting. "A" (AUTO), "PHOTO" or "TEXT"
2	Copy density (density level)	Indicates the density level for the copy density setting.
3	Paper source	Indicates the selected paper tray. If special paper is selected, the paper type is displayed. "AUTO" or a paper tray and paper size, paper type
4	Fax status Sub-messages	Indicates the current faxing status. Messages describing the current status (such as when warming up) appear.
5	Number of copies	Indicates the specified number of copies.
6	Zoom ratio	Indicates the current zoom ratio setting. "AUTO" or the current zoom ratio setting is displayed. "X [X/Y]" indicates that the "X/Y Zoom" function is selected.
7	Menu or function name	<ul style="list-style-type: none"> Displays the current menu, function or settings. Error messages are displayed when errors occur.
8	Messages	Displays messages such as operating instructions.

In Fax mode:

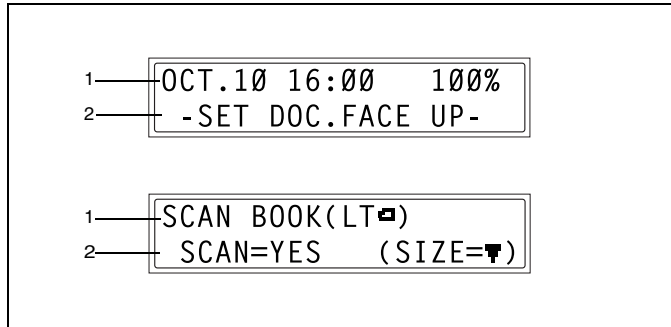

No.	Display Indication	Description
1	Mode or function name	<ul style="list-style-type: none"> Indicates the currently selected mode or function settings. Displays the current menu, function or settings. Error messages are displayed when errors occur. The current date and remaining memory is displayed during standby.
2	Messages	Displays messages such as operating instructions.

Symbol list:

Symbol		Description
	Manual bypass	Paper is loaded in the Manual Bypass Tray.
	Custom paper size	The paper setting for the Manual Bypass Tray is a custom paper size.
	Dialing	A fax number is being dialed.
	Ringing	The machine is being called.
	Sending	The document is being sent.
	Receiving	A document is being received.
	In standby for timer transmission	A document is queued for timer transmission.
	In standby for polling transmission	A document is queued for polling transmission.

3.6 Useful Operations

Canceling Settings

Press the [Panel Reset] key to cancel all modes and functions (zoom ratio, number of copies, recipient specified for fax transmission, fax resolution, etc.) and reset them to their defaults. (All selected settings are cancelled.)



Tip

Pressing the [Panel Reset] key is the easiest way to cancel all specified settings at the same time.

In order to avoid accidentally using settings from previous copy or fax jobs, press the [Panel Reset] key to return all functions to their defaults, and then select the desired settings.

Auto Panel Reset

The machine automatically resets all modes and functions to their defaults one minute after copying is finished or after a key is pressed, without the need for the [Panel Reset] key to be pressed.



Tip

The length of time until the machine automatically resets itself can be set to 30 seconds or any number of minutes between 1 and 5.

The "AUTO PANEL RESET" function can even be turned off.

For details, refer to "To set the "AUTO PANEL RESET" function" on page 9-4.



Note

While in Fax mode, the machine resets itself one minute after the last key was pressed, regardless of the "AUTO PANEL RESET" function setting.

Energy Saver Mode (Preheat Mode)

Instead of turning off the machine, it can be put into a standby mode (Energy Saver mode).

The Energy Saver mode can be turned on by pressing the [Energy Saver] key. In addition, if the machine is not used for a set length of time, it automatically enters Energy Saver mode. The default length of time until the machine enters Energy Saver mode is 15 min.

In order to conserve energy, the display in the Control Panel is turned off during preheat mode.

Cancel Energy Saver mode by pressing any key in the Control Panel.



Note

If the auto shut-off function activates while the machine is in Energy Saver mode, the machine is automatically turned off.



Tip

The length of time until the machine automatically enters Energy Saver mode can be set between 1 min and 240 min. For details, refer to “To set the “ENERGY SAVE MODE” (preheat mode) function” on page 9-5.

Auto Shut-Off

In order to conserve energy, this machine can be set to automatically shut off after a set length of time. As a default, the “AUTO SHUT OFF” function is turned off.



Tip

The length of time until the machine automatically shuts off can be set between 15 min and 240 min. Refer to page 9-6.

Queued Copy Jobs

If a document is loaded and the [Start] key is pressed after the machine is turned on but before it is ready to begin copying, the machine queues the job and automatically starts copying after it has finished warming up.

Interrupting Copy Jobs

During long continuous copy or print operations, the machine may be needed to quickly copy a different document. Press the [Interrupt] key to temporarily stop the current copy operation.

Press the [Interrupt] key again to continue the previously stopped copy operation.



Note

Some functions cannot be interrupted. In addition, some functions are not available while a copy job is interrupted. For details, refer to "Function Combination Table" on page 14-11.

Auto Paper Source Change Feature

If the paper tray runs out of paper while copying, the machine will automatically switch to a different paper source and continue copying provided that the new tray contains paper of the same type and size in the same orientation.

Access Numbers

If user (section) access numbers have been specified, use of the machine can be limited to specific users or to a specified number of copies for each account.



Note

If access numbers have been specified, the machine cannot be used unless the access number is entered first.

Access number input screen:

- In order to use this function, the access numbers must be specified with the "COPY TRACK" function from the "ADMIN. MANAGEMENT" menu (p. 9-22).

ACCESS NO. = ---

To enter an access number

- 1 Using the 10-Key Pad, enter the 3-digit account (section) access number.

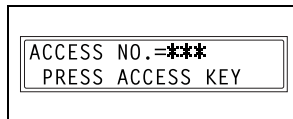

- If you wish to correct the entered access number, press the [No] key, and then enter the correct number.

- 2 Press the [Access] key.

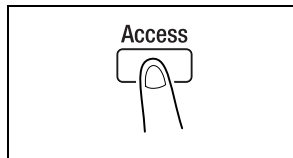

- 3 The main screen of the initial mode appears and copying can be started. Select the desired settings.
- 4 When you are finished making copies, press the [Access] key.

Printing From the Computer

If the optional Printer Controller is installed, the machine can be used as a printer.

For operating instructions, refer to the User Manual enclosed with the Printer Controller.

Scanning From the Computer

If the enclosed TWAIN Driver is installed, the machine can be used as a scanner for a computer.

For operating instructions, refer to the instruction manual enclosed with the TWAIN Driver.

3.7 Power Switch and Default Settings



Note

Do not turn off the machine while it is making copies or printing, otherwise a paper misfeed may occur. Make sure that all copy/print operations are finished before turning off the machine.

Do not turn off the machine while it is sending or receiving a fax, otherwise a transmission error or paper misfeed may occur. Make sure that all fax transmissions/receptions are finished before turning off the machine.



Note

When the machine is turned off, all settings except the stored copy programs and Utility mode settings are reset to their defaults.

If the machine is not used for 15 min, it automatically enters Energy Saver mode.

The length of time until the machine enters Energy Saver mode or automatically shuts off can be specified using functions in the Utility mode. For details, refer to "Specifying Machine Settings ("MACHINE SETTING" Menu)" on page 9-2.

Turning the Machine On and Off

To turn on the machine

- Set the Power Switch to "I".

To turn off the machine

- Set the Power Switch to "O".

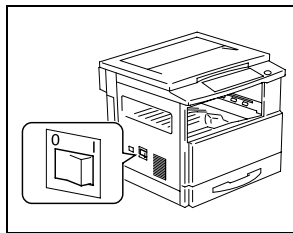

Turning On the Machine

After the machine is turned on, the indicator on the [Start] key lights up in orange and “PLEASE WAIT!” appears in the display while the machine warms up.

At this time, a document can be loaded into the Automatic Document Feeder and the [Start] key pressed to queue the job. (p. 3-25)

Even though the [Start] key is pressed, the copy operation does not begin until the machine has finished warming up (after about 30 seconds at a room temperature of 73.4°F (23°C)).

Default Settings

The settings that are automatically selected when the machine is turned off or the [Panel Reset] key is pressed are called the “default settings”. These settings serve as a reference for all functions.

Copy mode

- Number of copies: 1
- Copy density: AUTO
- Zoom ratio: Full size (× 1.00)
- Paper source: AUTO (with the Automatic Document Feeder installed)
- Finishing function: Non-sort

Fax mode

- Resolution: Standard
- Contrast: Medium
- Transmission mode: Memory transmission
- Reception mode: Automatic reception
- Paper size/source priority: Priority to the paper size
- Transmission source: Within document



Tip

The default settings can be customized using the functions in the Utility mode (“9 Utility Mode – Copy Functions” and “10 Utility Mode – Fax Functions”).

3.8 Selecting and Checking Initial Settings

In order for the many functions of this machine to be used to their fullest capacity, certain settings including the time and one-touch dial key must first be specified.

In addition, several settings, such as when the various reports are printed, are specified during production, but can be changed as required. Before starting to operate this machine, check these settings.

Required Settings

Before using the machine, the following must be specified.

- Current date/time
- User fax number
- Phone dialing system
- Communication (external/internal) settings

If the following are specified, the machine can be used more efficiently.

- Transmission source (your name and fax number)
- One-touch dial keys
- Speed dial numbers
- Programmed fax functions and numbers

Checking the Initial Settings

Since each function has been set during production, their settings should be checked, then changed as necessary. (Refer “9 Utility Mode – Copy Functions” to and “10 Utility Mode – Fax Functions”.)

To set the current date and time

- 1 Press the [Utility] key.

The first screen of the Utility mode appears.

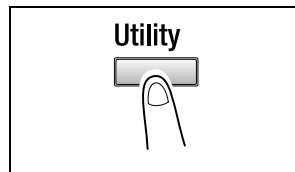

- 2 Press the ▼ key 11 times to select "INITIAL USER DATA".

- 3 From the 10-Key Pad, press the [1] key.

A screen appears, allowing you to specify the time and date.

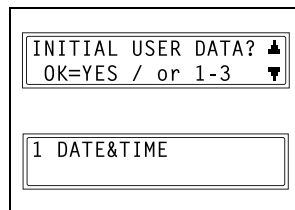

- 4 Using the 10-Key Pad, enter the time.

- The time is set on a 24-hour system.

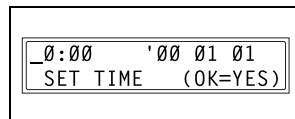

- 5 Using the 10-Key Pad, enter the date (year, month and day).

- For the year, enter the last two digits.
- In the screen that allows you to set the time and date, press the ◀ and ▶ keys to move the cursor (_) to the desired location.

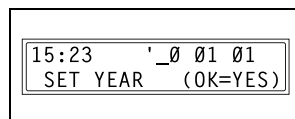

- 6 Press the [Yes] key.

The "INITIAL USER DATA" menu appears again.



Note

The time setting of this machine automatically switches to daylight savings time during the period indicated below.

From 2 am on the first Sunday of April to 2 am on the last Sunday of October

To specify the user fax number

The user fax number is the fax number that will appear in the header of faxes sent from this machine.

The fax number can contain a maximum of 20 digits.

The keys that can be used to enter the fax number are: the number keys (0 through 9), Space, + and -.

- 1 Press the [Utility] key.

The first screen of the Utility mode appears.

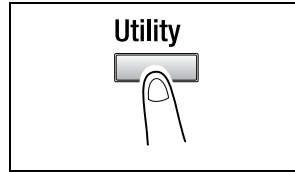

- 2 Press the ▼ key 11 times to select "INITIAL USER DATA".

- 3 From the 10-Key Pad, press the [2] key.

A screen appears, allowing you to enter the user fax number.

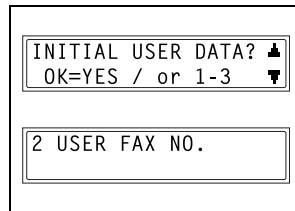

- 4 Using the 10-Key Pad, enter the user fax number.

- If you wish to correct the entered number, press the [No] key, and then enter the new number.

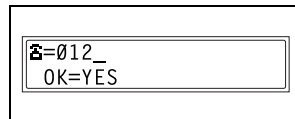

- 5 Press the [Yes] key.

The "INITIAL USER DATA" menu appears again.

To program the user name

The user name is the name that will appear in the header of faxes from this machine.

The transmission source information is printed at the top of sent faxes. The user name can be a maximum of 32 characters long.

- 1 Press the [Utility] key.

The first screen of the Utility mode appears.

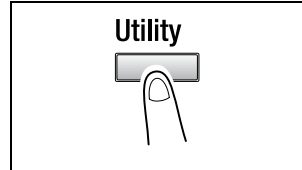

- 2 Press the ▼ key 11 times to select "INITIAL USER DATA".

- 3 From the 10-Key Pad, press the [3] key.

A screen appears, allowing you to enter the user name.

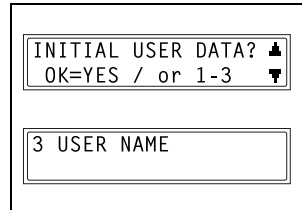

- 4 Enter the user name using the one-touch dial keys.

- For details on entering text, refer to "Entering Text" on page 3-36.

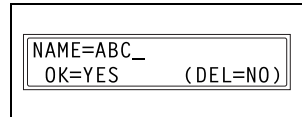

- 5 Press the [Yes] key.

The "INITIAL USER DATA" menu appears again.

Specifying the Phone Dialing System

There are two types of telephone dialing systems: tone dialing (PB) and pulse dialing (DP10pps or DP20pps). Faxes cannot be sent if this machine is not set to the system used by your telephone line. Select the correct setting after checking which type of dialing system is used.

To specify the telephone dialing system

- 1 Press the [Utility] key.

The first screen of the Utility mode appears.

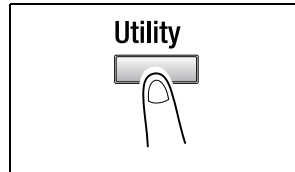

- 2 Press the ▼ key 9 times to select "COMM.SETTING".

- 3 From the 10-Key Pad, press the [1] key.

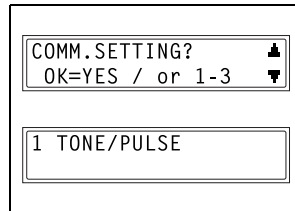

- 4 Using the ◀ and ▶ keys, select either "TONE" (for tone dialing) or "PULSE" (for pulse dialing), and then press the [Yes] key.

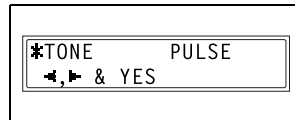

- 5 If "PULSE" was selected, select either "10pps" or "20pps", and then press the [Yes] key.

The "COMM.SETTING" menu appears again.

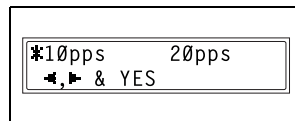

Specifying the Phone Wiring System

The connected wiring system can be set to either PSTN (Public Switched Telephone Network) or PBX (Private Branch Exchange).

For a PBX system, the outside line access number (or extension number) must be specified. The outside line access number (or extension number) is programmed in the [#] key.

To specify the telephone wiring system

- 1 Press the [Utility] key.

The first screen of the Utility mode appears.

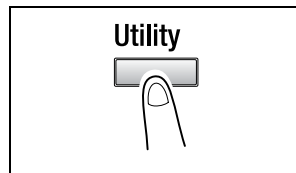

- 2 Press the ▼ key 9 times to select “COMM.SETTING”.

- 3 From the 10-Key Pad, press the [3] key.

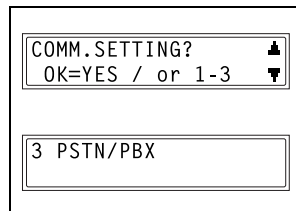

- 4 Using the ◀ and ▶ keys, select either “PSTN” (Public Switched Telephone Network) or “PBX” (Private Branch Exchange), and then press the [Yes] key.

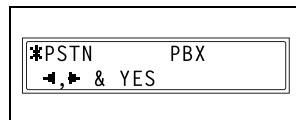

- 5 If “PBX” was selected, use the 10-Key Pad to enter the number that should be dialed to access the outside line, and then press the [Yes] key.

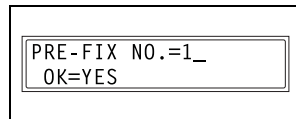

The “COMM.SETTING” menu appears again.

3.9 Entering Text

When specifying the user name or programming one-touch dial keys with the recipient name, letters, accented characters, numbers and symbols can be entered.

Key operation:

- One-touch dial keys [01] through [27]: Used to enter letters and symbols.
- 10-Key Pad: Used to enter numbers.

List of characters available with each one-touch dial key:

One-touch dial key		Available characters*	One-touch dial key		Available characters*
01	ABC	ABC	15	pqr	pqr
02	DEF	DEF	16	stu	stu
03	GHI	GHI	17	vwx	vwx
04	JKL	JKL	18	yz	yz
05	MNO	MNO	19	@	@
06	PQR	PQR	20	.	. (period)
07	STU	STU	21	_	_ (underscore)
08	VWX	VWX	22	+	+
09	YZ	YZ	23	-	- (hyphen)
10	abc	abc	24	&	&#*/!=?\$%[]'{} ^()" ,:;:<>
11	def	def	25		ÀáÂãÄåËÉíóúÀÌàçÆ Ñ¿Øøß
12	ghi	ghi	26	␣ Space	(space)
13	jkl	jkl	27	⌫ Delete	(deletes)
14	mno	mno			

* Repeatedly press the one-touch dial key to scroll through the corresponding characters and symbols listed until the desired character appears in the display.

Inputting Example

To enter the name "NJ Office"

* The cursor () flashes alternately with the character at its current location.

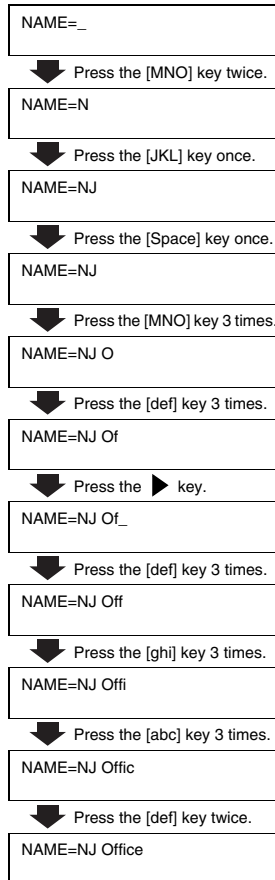

Correcting text and input precautions

- To erase all entered text, press the [No] key.
- To delete only part of the entered text, use the ◀ and ▶ keys to move the cursor (|) to the character that you wish to delete, and then press the [Delete] key (one-touch dial key [27]).
- To change an entered character, use the ◀ and ▶ keys to move the cursor (|) to the character that you wish to change, and then enter the new character. (The character at the cursor's position is replaced with the new character.)
- If the same one-touch dial key is needed to enter two characters in a row, press the ▶ key after selecting the first character. (Refer to the above example.)
- To enter a space, press one-touch dial key [26].

3.10 Copy Paper

Paper Specifications

1st Tray	Specifications
Paper types	Plain paper (16 lb to 24 lb), recycled paper Special paper: Cards (24-1/4 lb to 41-3/4 lb), OHP transparencies, postcards, and label sheets
Paper sizes	11 × 17 L to 5-1/2 × 8-1/2 Width: 3-9/16 to 11-11/16; Length: 5-1/2 to 17 In metric: A3 L to A5 C, FLS (8-1/4 × 13) Width: 3-9/16 to 11-11/16; Length: 5-1/2 to 17 * When the length is set between 16-9/16 inch and 17 inch, the maximum width that can be set is 11 inch. When the width is set between 11-1/16 inch and 11-11/16 inch, the maximum length that can be set is 16-1/2 inch.
Paper capacity	Plain or recycled paper: 250 sheets Special paper: 20 sheets

2nd (3rd/4th/5th) Tray	Specifications
Paper types	Plain paper (16 lb to 24 lb) and recycled paper
Paper sizes	11 × 17 L to 5-1/2 × 8-1/2 In metric: A3 L to A5 C, FLS (8-1/4 × 13)
Paper capacity	250 sheets

Manual Bypass Tray	Specifications
Paper types	Plain paper (16 lb to 24 lb), recycled paper Special paper: Cards (24-1/4 lb to 41-3/4 lb), OHP transparencies, postcards, and label sheets
Paper sizes	Width: 3-9/16 to 11-11/16; Length: 5-1/2 to 17
Paper capacity	1 sheet at a time

Multiple Bypass Tray	Specifications
Paper types	Plain paper (16 lb to 24 lb), recycled paper Special paper: Cards (24-1/4 lb to 41-3/4 lb), OHP transparencies, postcards, and label sheets
Paper sizes	Width: 3-9/16 to 11-11/16; Length: 5-1/2 to 17
Paper capacity	Plain or recycled paper: 50 sheets Special paper: 20 sheets

For details on loading the paper, refer to “When the Message “LOAD PAPER” Appears” on page 12-1.

Note:

- Load only copy paper of the specified type, size and amount, otherwise paper misfeeds or other problems may occur.
- If paper with a size in metric (A4, A3, etc.) is loaded into a paper tray, select the appropriate setting for the "INCH/METRIC" function in the Utility mode. (p. 9-13)
- If paper with a non-standard size is loaded into the 1st Tray, select the appropriate setting using the "TRAY1 PAPER" function in the Utility mode. (p. 9-14)
- If paper with a non-standard size is loaded into the Manual Bypass Tray or Multiple Bypass Tray, select paper size setting "CUSTOM" before making copies, and then enter the corresponding paper size. (p. 4-19)
- If cards, OHP transparencies, or postcards are loaded into the 1st Tray, select the appropriate setting using the "TRAY1 PAPER" function in the Utility mode. (p. 9-14)
- If cards, OHP transparencies, or postcards are loaded into the Manual Bypass Tray or Multiple Bypass Tray, select the appropriate paper type before making copies. (p. 4-15 or p. 4-17)
- If you do not want automatic paper size/paper source selection to be activated when recycled paper is loaded into a paper tray, select the appropriate setting using the "AUTO SELECT" function in the Utility mode. (p. 9-16)
- If FLS paper with a size other than the default FLS size (8-1/4 × 13) is loaded, the setting must be changed. For details, contact your service representative.
- Do not load paper of different sizes into the same paper tray.

The following types of paper should not be used, otherwise decreased print quality, paper misfeeds or damage to the machine may occur.

- OHP transparencies that have already been fed through the machine (even if the transparency is still blank)
- Paper that has been printed on by a heat-transfer printer or an inkjet printer
- Paper that is either extremely thick or extremely thin
- Folded, curled (rolled), wrinkled, or torn paper
- Perforated paper or paper with punched holes
- Extremely smooth or extremely rough paper, or paper with an uneven surface
- Paper that has been treated, such as carbon-backed, heat-sensitive or pressure-sensitive paper
- Paper that has been decorated with foil or embossing
- Paper of a non-standard shape (not rectangular)
- Paper that is bound with glue, staples or paper clips
- Paper with labels attached
- Paper with ribbons, hooks, buttons, etc. attached

Print Area

Any part of the image within the area indicated below is not copied.

- A margin 1/4 inch (4 mm) from the leading edge of the paper (A)
- A margin 1/4 inch (4 mm) from the trailing edge of the paper (B)
- A margin 1/4 inch (4 mm) on both sides of the paper (C) (If the Printer Controller is installed and the machine is being used to print from a host computer, the image cannot be printed within the area 1/4 inch (4 mm) from all edges of the paper.)

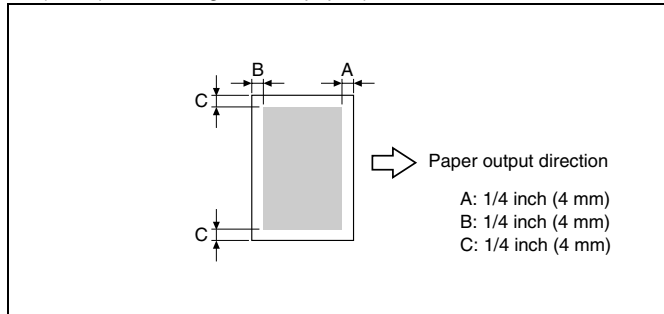

Paper Storage

Observe the following precautions when storing copy paper.

- Store the paper in a location that meets the following requirements.
 - Not exposed to direct sunlight
 - Not exposed to fire
 - Not exposed to high humidity
 - Not extremely dusty
- Unwrapped paper should be stored in a plastic bag in a cool, dry location.
- Keep paper out of the reach of children.

3.11 Original Documents

Document Feeding



Note

Be sure to use documents appropriate for the feed method being used, otherwise a paper misfeed or damage to the document may occur.

Document feed method	Document type	Document size
Automatic Document Feeder	Sheet documents Single-sided documents Capacity: 13-1/4 lb to 29-1/4 lb Documents of mixed sizes Capacity: 16 lb to 24 lb	11 × 17 L to 5-1/2 × 8-1/2 L Document width: 3-9/16 inch to 11-11/16 inch Document length: 8-1/4 inch to 17 inch
Original Glass	Sheet documents, books, and large objects Maximum weight: 6-1/2 lb	11 × 17 L to 5-1/2 × 8-1/2 L Document width: Up to 11-11/16 inch Document length: Up to 17 inch

Precautions for Loading Documents into the Automatic Document Feeder

The following types of documents should not be loaded into the Automatic Document Feeder, otherwise paper misfeeds or damage to the document may occur. Instead, these types of documents should be positioned on the Original Glass.

- Thin documents such as typewriter paper or paraffin paper
- Thick documents
- Standard size documents larger than 11 × 17 or smaller than 5-1/2 × 8-1/2
- Documents that are highly translucent or transparent such as OHP transparencies or diazo photosensitive paper
- Wrinkled, folded, curled (rolled), or torn documents
- Documents bound with glue, staples or paper clips
- Coated documents such as carbon-backed paper

Precautions for Positioning Documents on the Original Glass

The following precautions should be observed when positioning the above-listed types of documents on the Original Glass.

- For documents of a non-standard size:
The document size cannot be detected automatically; therefore, the “Auto Paper” and the “Auto Size” functions cannot be used. Press the [Paper] key and select the appropriate paper size (paper tray), or press the [Zoom] key and select the appropriate zoom ratio. (p. 4-11 and p. 4-21)
- For highly translucent or transparent documents (such as OHP transparencies or diazo photosensitive paper):
Place a blank sheet of paper of the same size over the document. (p. 4-1)
- For objects such as books (thick documents):
Scan without closing the Original Cover or Automatic Document Feeder. In addition, do not press down extremely hard on the document, otherwise the machine may be damaged. (The Original Glass can only resist a weight of up to 6-1/2 lb.)

4 Basic Copy Operations

4.1 Loading the Document

The document can be loaded into the Automatic Document Feeder (optional) or positioned on the Original Glass. Position the document correctly according to the type of document being copied.

With the Automatic Document Feeder

To load the document

- 1 Adjust the Document Guide Plates to fit the size of the document.

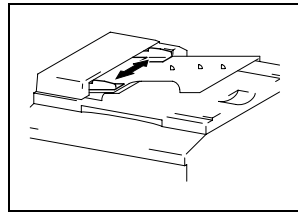

- 2 Load the document pages to be copied face up into the Automatic Document Feeder.

? *Have the necessary precautions been observed when loading the document?*

- A maximum of 50 document pages can be loaded.
- Do not load so many pages that the top of the stack is higher than the ▼ mark.
- Be sure to adjust the Document Guide Plates so that they are against the edges of the document, otherwise the document may not be fed in straight.
- The paper sizes that can automatically be detected when loaded into the Automatic Document Feeder are 11 × 17 L, 11 × 15 L, Legal L, Letter L, Letter C, 5-1/2 × 8-1/2 L, A4 L and A4 C. If paper of other sizes or non-standard sizes is loaded, the size cannot be detected or it may be detected incorrectly.

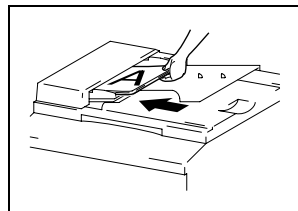

- Documents of mixed sizes can be loaded into the Automatic Document Feeder. Refer to “To load documents of mixed sizes” on page 4-2 for more information.
- 3** Select the desired copy settings. For details, refer to “Making Copies” on page 4-9 and “Advanced Copy Operations” on page 5-1.
- 4** Press the [Start] key to begin feeding and copying the loaded document pages, starting from the top page.

To load documents of mixed sizes

Documents containing pages of different sizes can be loaded as a set into the Automatic Document Feeder.

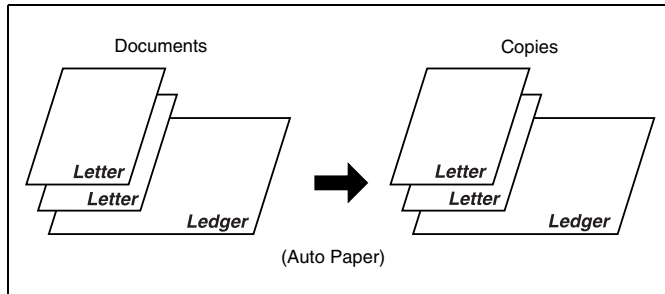

Precautions for loading documents of mixed sizes:

- ✓ Documents of different sizes can be copied only if all pages have the same width.
For example: A document consisting of Ledger L (11 × 17 L)- and Letter C-size pages

- 1 Open the Document Guide Plates.

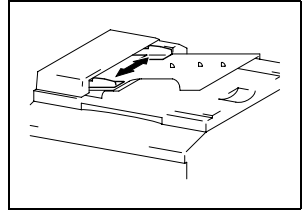

- 2 Load the document pages to be copied face up.

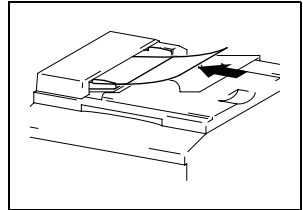

- 3 Adjust the Document Guide Plates to fit the size of the document.

? *Have the necessary precautions been observed when loading the document?*

- A maximum of 50 document pages can be loaded.
- Do not load so many pages that the top of the stack is higher than the ▼ mark.
- Be sure to adjust the Document Guide Plates so that they are against the edges of the document, otherwise the document may not be fed in straight.

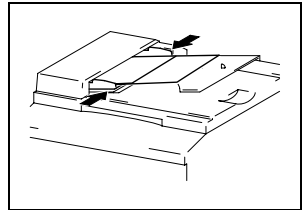

- 4 Press the [Original] key until the "Mixed Orig." indicator lights up.

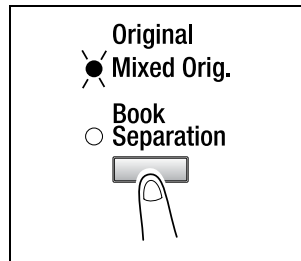

- 5 Press the [Auto Paper/Auto Size] key until the “Auto Paper” function is selected.
- Check that “AUTO” appears in the bottom line of the screen.

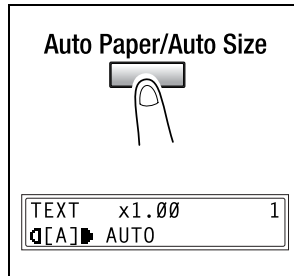

- 6 Press the [Start] key to begin feeding and copying the loaded document pages, starting from the top page.

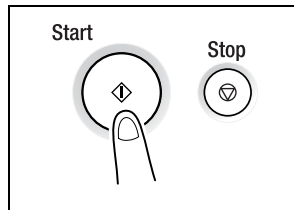

With the Original Glass

To position sheet documents

For plain documents or documents that cannot be loaded into the Automatic Document Feeder, position them as described below.

- 1 Lift open the Original Cover, or the Automatic Document Feeder if it is installed.
- 2 Position the document to be copied face down on the Original Glass.

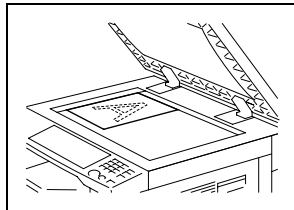

- 3 Align the document on the scales above and to the left of the Original Glass.

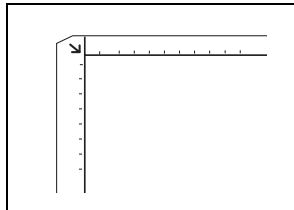

- 4 Carefully close the Original Cover, or the Automatic Document Feeder if it is installed.
- 5 Select the desired copy settings. For details, refer to “Making Copies” on page 4-9 and “Advanced Copy Operations” on page 5-1.
- 6 Press the [Start] key to copy the document.

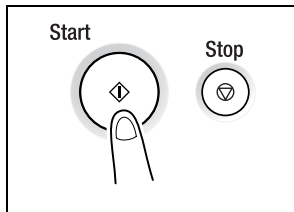

To position translucent or transparent documents

When copying a highly transparent or translucent document, such as OHP transparencies, tracing paper or diazo photosensitive paper, position it as described below.

- 1 Lift open the Original Cover, or the Automatic Document Feeder if it is installed.

- 2 Position the document to be copied face down on the Original Glass.

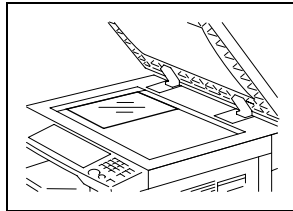

- 3 Align the document on the scales above and to the left of the Original Glass.

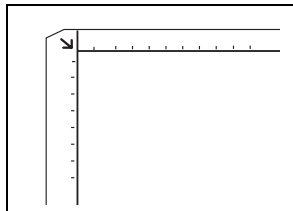

- 4 Place a blank sheet of paper of the same size over the document.

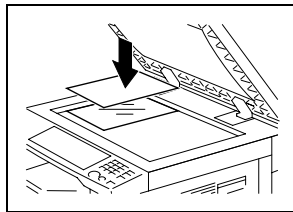

- 5 Carefully close the Original Cover, or the Automatic Document Feeder if it is installed.

- 6 Select the desired copy settings. For details, refer to “Making Copies” on page 4-9 and “Advanced Copy Operations” on page 5-1.

- 7 Press the [Start] key to copy the document.

To position a book

When copying two facing pages of a bound document, such as a book or magazine, position it as described below.

- 1 Lift open the Original Cover, or the Automatic Document Feeder if it is installed.

- 2 Position the book face down onto the Original Glass, with the top of the book toward the rear of the machine and with the center of the book aligned with the  mark in the Document Scale.

? *Have the necessary precautions been observed when positioning the book on the Original Glass?*

- Do not place objects weighing more than 6-1/2 lb on the Original Glass. In addition, do not press down extremely hard on the document, otherwise the machine may be damaged.

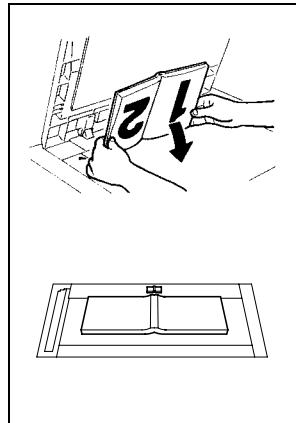

- 3 Carefully close the Original Cover, or the Automatic Document Feeder if it is installed.

? *Is a thick book or object being copied?*

- Make the copy without closing the Original Cover or Automatic Document Feeder. When the document is being scanned without closing the Original Cover or Automatic Document Feeder, do not look directly at the bright light that may shine through the Original Glass. Although the light that shines through the Original Glass is bright, it is not a laser beam and, therefore, is not as dangerous.

- 4 Press the [Original] key until the "Book Separation" indicator lights up.

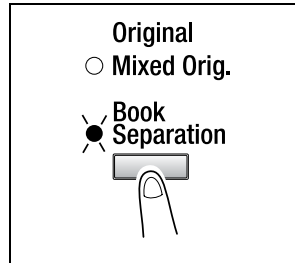

- 5 Select the desired copy settings. For details, refer to "Making Copies" on page 4-9 and "Advanced Copy Operations" on page 5-1.
- 6 Press the [Start] key to copy the document.

4.2 Making Copies

The following procedure describes how to load documents and make a simple copy of it.

To make a simple copy

- 1 Press the [Copy] key to enter Copy mode.

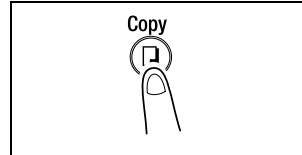

- 2 Load the document to be copied.
 - Refer to "Loading the Document" on page 4-1.

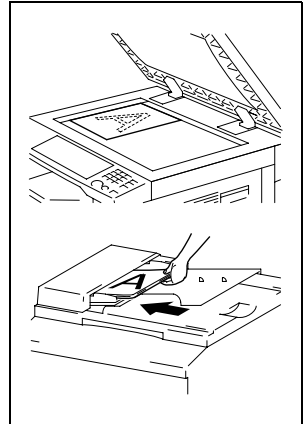

- 3 Select the desired copy settings.
 - Paper (p. 4-11)
 - Zoom (p. 4-21)
 - Copy density (p. 4-25)

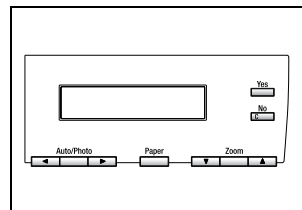

- 4 Using the 10-Key Pad, enter the desired number of copies. The number of copies can be set to any number between 1 and 99.

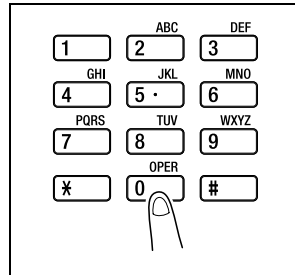

- 5 Press the [Start] key.
The set number of copies are made. To stop copying before the set number of copies have been made, press the [Stop] key.

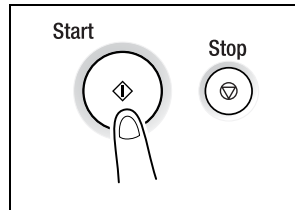

4.3 Selecting the Paper Source

Before making a copy, the paper tray containing the paper that will be used must be selected. Either the paper source is selected automatically when the size of the document is detected, or the desired paper source can be selected manually.

- **Auto Paper:**
If the “Auto Paper” function is selected, the paper tray containing the most suitable size of paper is selected based on the size of the document and the specified.
- **Manual paper selection:**
The paper tray containing the paper that you wish to use can be selected.



Note

The Automatic Document Feeder (optional) is needed for copying with the “Auto Paper” function.

To make copies using the “Auto Paper” function

- 1 Load the document into the Automatic Document Feeder.
 - Refer to “Loading the Document” on page 4-1.
- 2 Press the [Auto Paper/Auto Size] key until the “Auto Paper” function is selected.
 - Check that “AUTO” appears in the bottom line of the screen.

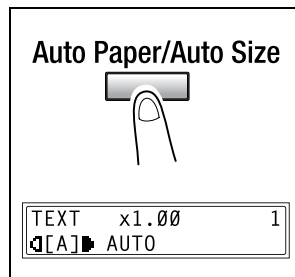

- 3 If necessary, specify any other copy settings.
 - Zoom (p. 4-21)
 - Copy density (p. 4-25)
- 4 Using the 10-Key Pad, enter the desired number of copies, and then press the [Start] key.

**Note**

If “NO SUITABLE PAPER” appears in the display immediately after the [Start] key is pressed, no tray is loaded with paper of the most suitable size. Either load paper with the appropriate size, or press the [Paper] key and select the desired paper size, and then press the [Start] key again.

To copy with a manually selected paper size

- 1 Load the document to be copied.
 - Refer to “Loading the Document” on page 4-1.
- 2 Press the [Paper] key, and then select the desired paper size.
 - Check that the correct document size appears in the bottom line of the screen.

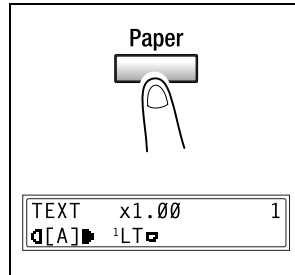

- 3 If necessary, specify any other copy settings.
 - Zoom (p. 4-21)
 - Copy density (p. 4-25)
- 4 Using the 10-Key Pad, enter the desired number of copies, and then press the [Start] key.

To copy onto special paper (1st Tray)

If special paper, such as OHP transparencies, postcards or cards, are loaded into the 1st Tray, first set the “TRAY1 PAPER” function in the “PAPER SOURCE SETUP” menu of the Utility mode (“To specify the size of paper loaded into the 1st Tray (“TRAY1 PAPER” function)” on page 9-14).

Depending on the paper type set for the “TRAY1 PAPER” function, the screen changes as shown below.

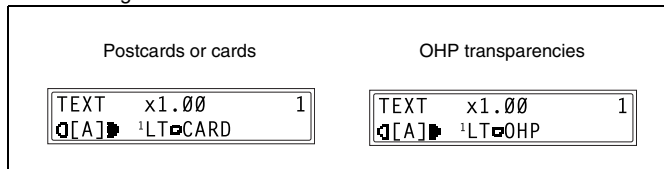

4.4 Making Copies on Manually Fed Paper

Manually feed the copy paper if you wish to make copies onto paper not loaded into any paper tray or onto special paper, such as OHP transparencies, postcards or cards.

Paper That Can Be Fed Manually

Paper types:

- Plain or recycled paper (thickness: 16 lb to 24 lb)
- Special paper
- Cards (thickness: 24-1/4 lb to 41-3/4 lb)
- OHP transparencies
- Postcards
- Label sheets

Paper sizes:

- Maximum: 11-11/16 × 17
- Minimum: 3-9/16 × 5-1/2



Note

When copying using the Manual Bypass Tray, only one page at a time can be loaded. However, if the Multiple Bypass Tray (optional) is installed, up to 50 sheets of paper can be loaded and fed manually. For cards, postcards and OHP transparencies, up to 20 sheets can be loaded.

Copying Onto Manually Fed Paper

To copy using the Manual Bypass Tray

- 1 Load the document to be copied.
 - Refer to “Loading the Document” on page 4-1.

- 2 Adjust the paper guides to fit the size of the paper, and then insert one sheet of paper with the front side facing down, lightly sliding the paper as much as possible into the feed slot.

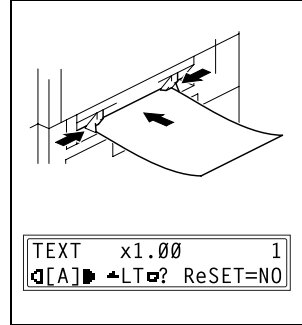

The manual bypass mark appears in the bottom line of the screen.

? *Is a card or a postcard loaded?*

- Make sure that it is not curled (rolled).

- 3 Press the [No] key (“RESET”), and then use the ◀ and ▶ keys to select the type of paper loaded.

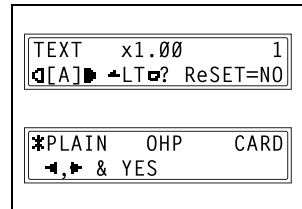

- 4 Press the [Yes] key.
- 5 Using the ◀ and ▶ keys, select the size of paper loaded.
 - If “OHP” was selected in step 3, set the paper size to Letter C or Letter L.



- If paper with a non-standard size is loaded, press the ▼ key (“CUSTOM”), and then use the 10-Key Pad to enter the paper size. (For details, refer to page 4-19.)

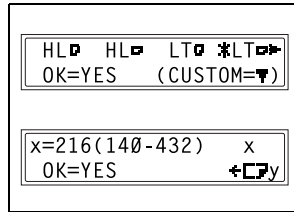

- 6 Press the [Yes] key.
- 7 If necessary, specify any other copy settings.
 - Zoom (p. 4-21)
 - Copy density (p. 4-25)
- 8 Press the [Start] key.



Tip

*To copy onto more pages using the same settings, feed paper into the Manual Bypass Tray to begin making copies automatically.
To make continuous copies onto cards, postcards or OHP transparencies, load them into the 1st Tray. (“To load paper into the 1st Tray” on page 12-1)*

To copy using the Multiple Bypass Tray

- 1 Load the document to be copied.
 - Refer to “Loading the Document” on page 4-1.

- 2 Adjust the Bypass Tray Extender and the paper guides to fit the size of the paper, and then load the paper with the front side facing down, lightly sliding the paper as much as possible into the feed slot.

The manual bypass mark appears in the bottom line of the screen.

? *Are sheets of cards or postcards loaded?*

- Make sure that they are not curled (rolled).

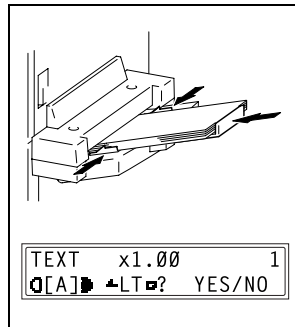

- 3 Press the [No] key, and then use the ◀ and ▶ keys to select the type of paper loaded.

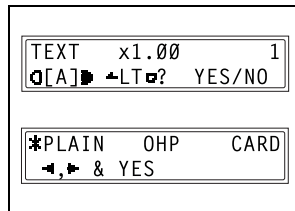

- 4 Press the [Yes] key.
- 5 Using the ◀ and ▶ keys, select the size of paper loaded.

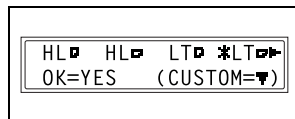

- If paper with a non-standard size is loaded, press the ▼ key (“CUSTOM”), and then use the 10-Key Pad to enter the paper size. (For details, refer to page 4-19.)
- If “OHP” was selected in step 3, set the paper size to Letter C or Letter L.

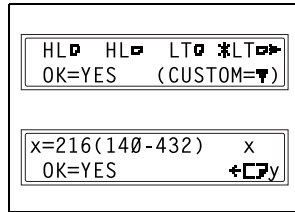

- 6** Press the [Yes] key.
- 7** If necessary, specify any other copy settings.
 - Zoom (p. 4-21)
 - Copy density (p. 4-25)
- 8** Press the [Start] key.

To copy onto a custom paper size

Precautions for entering custom paper sizes:

- ✓ When entering a custom paper size, be sure to specify the width and length measurements correctly.
- ✓ When using the 10-Key Pad to enter a custom paper size, the values are entered in millimeters. The conversion ratio is shown below.
1 inch = 25.4 mm

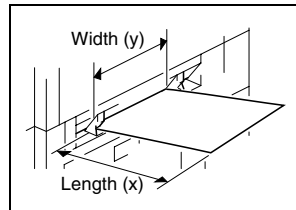

- 1 Load the document to be copied.
- 2 Load the paper into the Manual Bypass Tray.
- 3 Press the [No] key, and then use the ◀ and ▶ keys to select the type of paper loaded.
- 4 Press the [Yes] key.
- 5 Press the ▼ key ("CUSTOM").

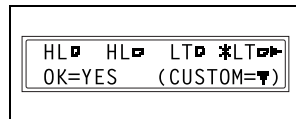

- 6 Using the 10-Key Pad, enter the length (mm) of the loaded paper.

- The paper length can be set between 5-1/2 inch (140 mm) and 17 inch (432 mm).
- If you wish to correct the entered setting, press the [No] key, and then use the 10-Key Pad to enter the new number.

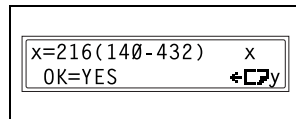

- 7 Press the [Yes] key.

8 Using the 10-Key Pad, enter the width (mm) of the loaded paper.

- The paper width can be set between 3-9/16 inch (90 mm) and 11-11/16 inch (297 mm).
- If you wish to correct the entered setting, press the [No] key, and then use the 10-Key Pad to enter the new number.

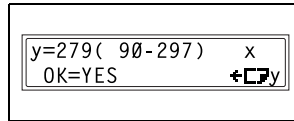

9 If necessary, specify any other copy settings.

- Zoom (p. 4-21)
- Copy density (p. 4-25)

10 Press the [Start] key.

4.5 Specifying a Zoom Setting

By specifying a zoom ratio, the copy can be enlarged or reduced.

Zoom Settings

"Zoom" setting	Description
Full size	Copies are made at the same size as the document ($\times 1.00$).
"AUTO" zoom ratio	The most appropriate zoom ratio is automatically selected based on the size of the document loaded and the specified paper size.
Preset zoom ratios	The following common zoom ratios for copying from various standard document sizes to standard paper sizes are available. $\times 0.50$ $\times 0.64$ (11 \times 17 \blacktriangleright Letter) $\times 0.78$ (Legal \blacktriangleright Letter) $\times 1.21$ (Legal \blacktriangleright 11 \times 17) $\times 1.29$ (Letter \blacktriangleright 11 \times 17) $\times 2.00$
Zoom ratios selected using the up and down Zoom keys	Using the \blacktriangle and \blacktriangledown keys, the zoom ratio can be adjusted (increased or reduced) in 0.01 increments. A zoom ratio between $\times 0.50$ and $\times 2.00$ can be set.
"X/Y Zoom" function	Copies can be made using different scaling proportions for the vertical and horizontal directions. Using the \blacktriangle and \blacktriangledown keys, the zoom ratio can be adjusted (increased or reduced) in 0.01 increments. The vertical and horizontal zoom ratios can be set between $\times 0.50$ and $\times 1.00$.

To make copies using the "AUTO" zoom setting

- Load the document to be copied.
 - Refer to "Loading the Document" on page 4-1.
- Press the [Auto Paper/Auto Size] key until the "Auto Size" function is selected.
 - Check that "AUTO" appears in the top line of the screen.

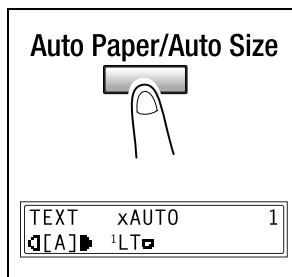

- 3 Press the [Paper] key, and then select the desired paper size.

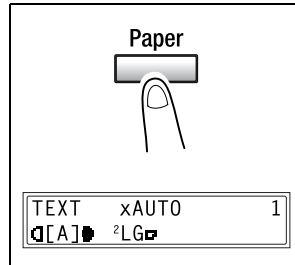

- 4 If necessary, specify any other copy settings.
 - Copy density (p. 4-25)
- 5 Using the 10-Key Pad, enter the desired number of copies, and then press the [Start] key.

To make copies using a specific zoom setting

- 1 Load the document to be copied.
 - Refer to “Loading the Document” on page 4-1.

- 2 Press the [Zoom] key, and then select the desired zoom ratio.
 - To select a specific zoom ratio, use the ▲ and ▼ keys to specify the desired zoom ratio. The zoom ratio increases and decreases in 0.01 increments.

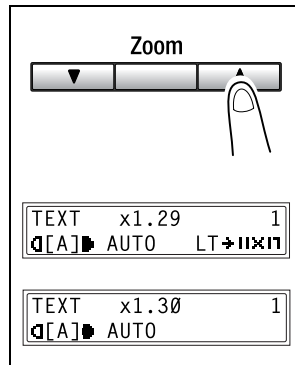

- 3 If necessary, specify any other copy settings.
 - Paper (p. 4-11)
 - Copy density (p. 4-25)
- 4 Using the 10-Key Pad, enter the desired number of copies, and then press the [Start] key.

To make copies using the “X/Y Zoom” function

- 1 Load the document to be copied.
 - Refer to “Loading the Document” on page 4-1.
- 2 Press the [X/Y Zoom] key until the “X/Y Zoom” indicator lights up.

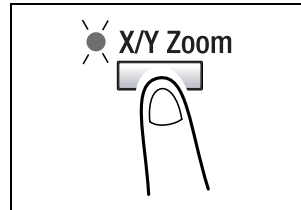

- 3 Using the ▲ and ▼ keys, select the desired zoom ratio for the length (X), and then press the [Yes] key.
 - The zoom ratio increases and decreases in 0.01 increments.
 - Press the [No] key to reset the zoom ratio to “× 1.00”.
 - The zoom ratio can be changed by using the [Zoom] key. Each press of the [Zoom] key changes the zoom ratio as shown below.
 $\times 0.50 \rightarrow \times 0.64 \rightarrow \times 0.78 \rightarrow \times 1.00 \rightarrow \times 0.50 \dots$

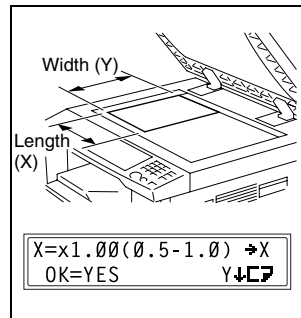

- 4 Using the ▲ and ▼ keys, select the desired zoom ratio for the width (Y), and then press the [Yes] key.
 - The zoom ratio increases and decreases in 0.01 increments.
 - Press the [No] key to reset the zoom ratio to “× 1.00”.
 - The zoom ratio can be changed by using the [Zoom] key. The zoom ratios that can be selected are shown in the step above.

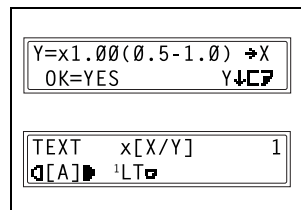

- 5 If necessary, specify any other copy settings.
 - Paper (p. 4-11)
 - Copy density (p. 4-25)
- 6 Using the 10-Key Pad, enter the desired number of copies, and then press the [Start] key.

4.6 Specifying the Copy Density (“Auto/Photo” function)

Document type and copy density settings

- “TEXT” setting:
The automatic density level and 5 manual density levels are available.
- “AUTO” density level:
The density level is automatically adjusted according to the document being copied.
- Manual density levels:
In order to prevent the image on the back of newspaper or magazine articles from appearing in the copy, press the ◀ key to select a level toward “LIGHT”. In order to copy pale colors in bright areas of an image, press the ▶ key to select a level toward “DARK”. Since selecting a level too much toward “DARK” may copy the media color or selecting a level too much toward “LIGHT” may produce a very faint copy, select the appropriate level depending on the document.
- “PHOTO” setting:
Select this setting when copying documents with many areas with varying halftones, such as photos.

To make copies after specifying a copy density

- 1 Load the document to be copied.
 - Refer to “Loading the Document” on page 4-1.

- 2 Press the [Auto/Photo] key to select between the “[A]” (AUTO), “PHOTO” and “TEXT” settings.
 - The current setting appears on the left side of the screen.

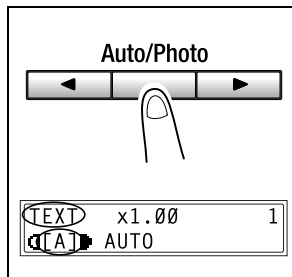

- 3 If the “PHOTO” or “TEXT” setting was selected, use the ◀ and ▶ keys to adjust the density level.

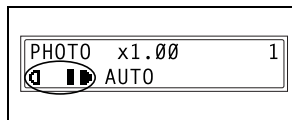

- 4 If necessary, specify any other copy settings.
 - Paper (p. 4-11)
 - Zoom (p. 4-21)
- 5 Using the 10-Key Pad, enter the desired number of copies, and then press the [Start] key.

4.7 Interrupting Copy Jobs

Long continuous copy operations can quickly be paused by pressing the [Interrupt] key in order to copy a different document.



Note

Some functions cannot be interrupted. In addition, some functions are not available while a copy job is interrupted. For details, refer to “Function Combination Table” on page 14-11.

To interrupt a copy job

- 1 Press the [Interrupt] key. The “Interrupt” indicator lights up and the current copy operation is paused.
 - When the [Interrupt] key is pressed, all functions are reset to their defaults.

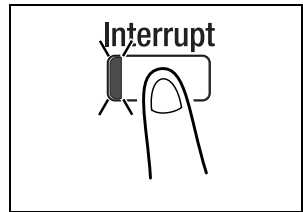

- 2 Remove the current document, and then load the other document that you wish to copy.

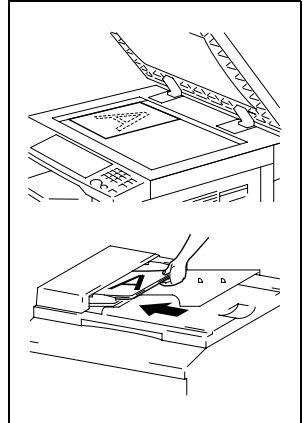

- 3 If necessary, specify any other copy settings.
 - Paper (p. 4-11)
 - Zoom (p. 4-21)
 - Copy density (p. 4-25)

- 4 Using the 10-Key Pad, enter the desired number of copies, and then press the [Start] key to copy the other document.
- 5 After the other document is copied, press the [Interrupt] key. The "Interrupt" indicator goes off, and all copy functions return to their previous settings.
- 6 Reload the document that was removed in step 2.
- 7 Press the [Start] key to continue the interrupted copy job.

5 Advanced Copy Operations

5.1 Single-Sided Copies

The setting combinations of the various document and copy types and the procedures for selecting the appropriate settings are described below. Using the various functions available by pressing the [Original] and the [Copy] keys, you can select the most suitable copy method.

Copy methods

- **Single-sided copies:**
A single-sided copy is produced from a single-sided document.

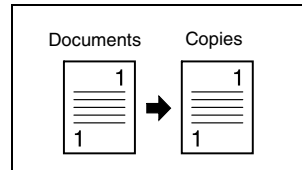

- **“2in1” copy function:**
A single-sided copy is produced from two single-sided document pages.
- **Important:**
This function is only available when the Automatic Document Feeder is installed.

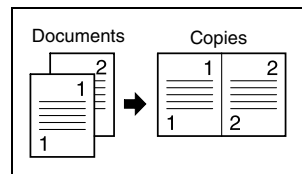

- **“4in1” copy function:**
A single-sided copy is produced from four single-sided document pages.
- **Important:**
This function is only available when the Automatic Document Feeder is installed.

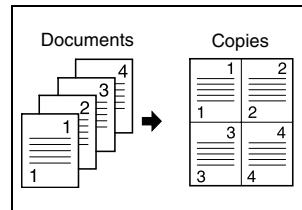

- **“Book Separation” function:**
A single-sided copy is produced from each of the two pages of an open book.

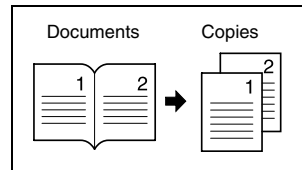

To make copies using the “2in1” (or “4in1”) copy function

- 1 Load the document to be copied into the Automatic Document Feeder.
 - Refer to “Loading the Document” on page 4-1.

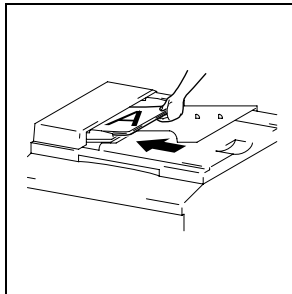

- 2 Press the [Copy] key until the “2in1” (or “4in1”) indicator lights up.

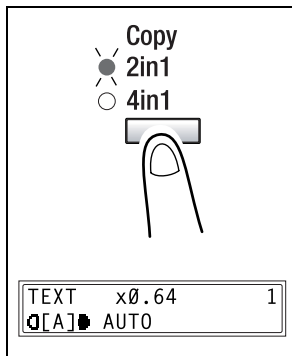

- 3 If necessary, specify any other copy settings.
- 4 Using the 10-Key Pad, enter the desired number of copies, and then press the [Start] key.

To make copies using the “Book Separation” function

- 1 Load the document to be copied.
 - Refer to “Loading the Document” on page 4-1.

- 2 Press the [Original] key until the “Book Separation” indicator lights up.
 - The default binding setting is for left-bound books. To copy right-bound books, change the document type using the “BINDING POS.” function in the Utility mode (p. 9-35).

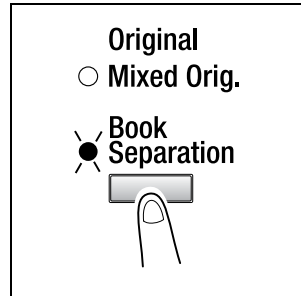

- 3 To erase the area around the text and/or the binding of the book, press the [Erase] key to select the desired erase setting. There are three erase settings available.

- “Frame” erase setting
The pages are copied with a blank area framing the text.

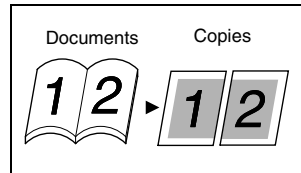

- “Center” erase setting
The pages are copied with a blank area along the binding.

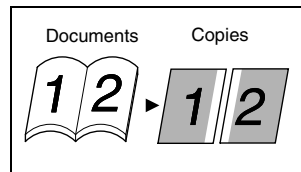

- “Frame” and “Center” erase settings
The pages are copied with blank areas framing the text and along the binding.

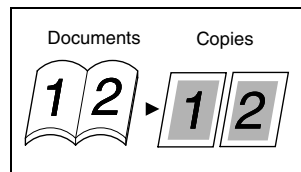

? *Do you know how large of an area is erased?*

- The width of the erased area for the “Frame” setting can be set between 1/4 inch (5 mm) and 3/4 inch (20 mm), in 1 mm (Approx. 1/16 inch) increments. The default setting is 1/2 inch (10 mm).
- The width of the erased area for the “Center” setting is fixed at 1/2 inch (10 mm).
- The width of the erased area for the “Frame” setting can be changed using the “ERASE SETTING” function in the Utility mode (p. 9-36).

4 If necessary, specify any other copy settings.

5 Using the 10-Key Pad, enter the desired number of copies, and then press the [Start] key.

5.2 Finishing Copies (“Sort” and “Group” functions)

When copying or printing two or more sets of a document, the copies can be divided either by sets containing a copy of each page (sorted) or by pages (grouped).

Finishing methods

- **Non-sort:**
The copies are stacked on top of each other as they are fed out.
- **“Sort” function:**
The copies are automatically divided into sets with each set containing a copy of each page.
- **“Group” function:**
The copies are automatically divided into stacks containing all copies of the same page.

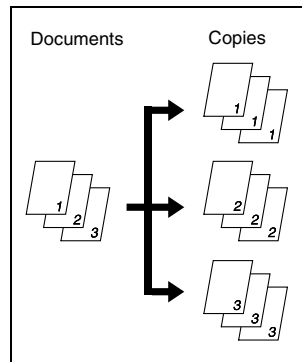
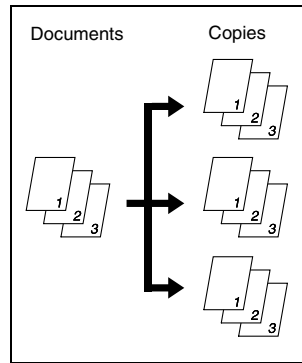
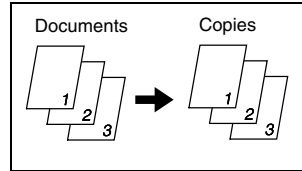

Sorting

The copies are fed out automatically separated into sets.

There are three ways of sorting: electronic sorting, shifted sorting and crisscross sorting.

- Electronic sorting
The copies are fed out automatically divided into sets containing one copy of each page.
- The Automatic Document Feeder must be installed.

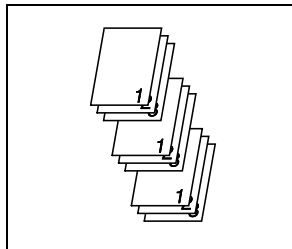

- Shifted sorting
Sets containing one copy of each page are fed out in an alternating shifted pattern.
- The Automatic Document Feeder and Shifting Unit must be installed.

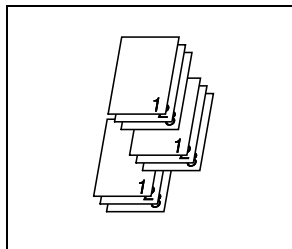

- Crisscross sorting
Sets containing one copy of each page are fed out in an alternating crisscross pattern.
- The Automatic Document Feeder and Paper Feed Cabinet (or Multiple Bypass) must be installed.

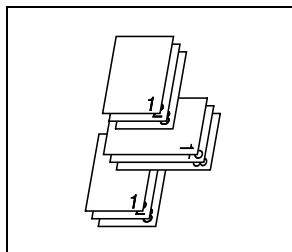

Note

For crisscross sorting, paper of the same size and type must be loaded horizontally in one paper tray and vertically in another tray.

Crisscross sorting is not possible if the Shifting Unit is installed.

Grouping

The copies are fed out automatically separated by page.

There are three ways of grouping: grouping, shifted grouping and crisscross grouping.

- **Grouping**
All copies of a single page are fed out in sets.
- The Automatic Document Feeder must be installed.

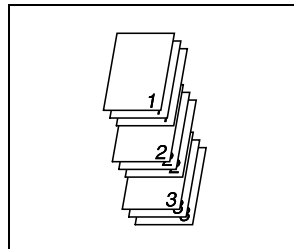

- **Shifted grouping**
Sets containing all copies of a single page are fed out in an alternating shifted pattern.
- The Automatic Document Feeder and Shifting Unit must be installed.

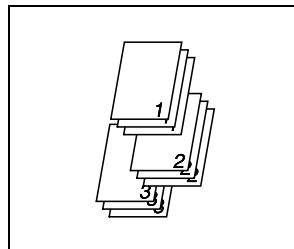

- **Crisscross grouping**
Sets containing all copies of a single page are fed out in an alternating crisscross pattern.
- The Automatic Document Feeder and Paper Feed Cabinet (or Multiple Bypass) must be installed.

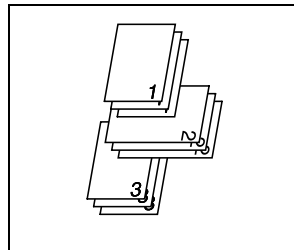

Note

For crisscross grouping, paper of the same size and type must be loaded horizontally in one paper tray and vertically in another tray. Crisscross grouping is not possible if the Shifting Unit is installed.

Specifying Finishing

To make copies using a Finishing function

- 1 Load the document to be copied into the Automatic Document Feeder.
 - Refer to “Loading the Document” on page 4-1.

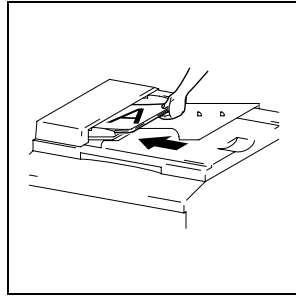

- 2 Press the [Finishing] key until the indicator for the desired Finishing function lights up.
 - ? *Are neither the “Sort” nor the “Group” indicators lit?*
 - The “Non-sort” setting is selected.

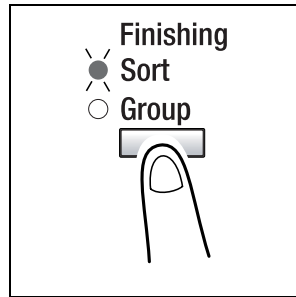

- 3 If necessary, specify any other copy settings.
- 4 Using the 10-Key Pad, enter the desired number of copies, and then press the [Start] key.

5.3 Erasing Sections of Copies

Areas such as the unclean-looking frames around copies can be erased.

The “Erase” function can be set to one of four settings.

- “Left” erase setting:
The left side of the document is erased from the copy.

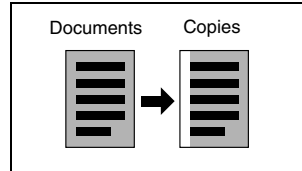

- “Upper” erase setting:
The top of the document is erased from the copy.

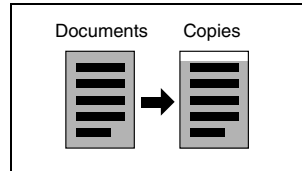

- “Frame” erase setting:
A frame around the document is erased from the copy.

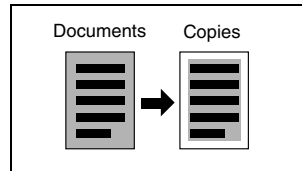

- “Center” erase setting:
A section along the center of the document is erased from the copy.

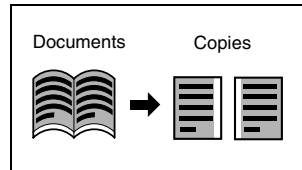

Note

This setting is only available when the “Book Separation” function is set.







Tip

If the “Book Separation” function is set, the “Frame” and the “Center” erase settings can be combined (p. 5-3).

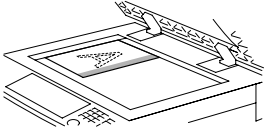
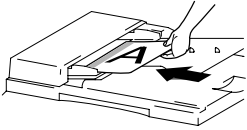
Precautions on the Erased Margin Location

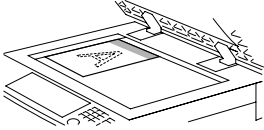
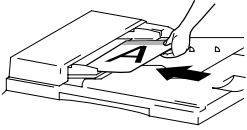
The location of the erased area in the copy depends on how the document is positioned.

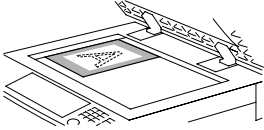
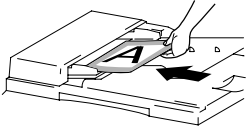
"Erase" setting	Original Glass	Automatic Document Feeder
Left 		
Upper 		
Frame 		

Setting the “Erase” Function

To make copies using an “Erase” setting

- 1 Load the document to be copied.
 - Refer to “Loading the Document” on page 4-1.

- 2 Press the [Erase] key until the indicator for the desired “Erase” setting lights up.

? *Do you know how large of an area is erased?*

- The width of the erased area for the “Left”, “Upper” and “Frame” settings can be set between 1/4 inch (5 mm) and 3/4 inch (20 mm), in 1 mm (Approx. 1/16 inch) increments. The default setting is 1/2 inch (10 mm).
 - The width of the erased area for the “Center” setting is fixed at 1/2 inch (10 mm).
 - The width of the erased area for the “Left”, “Upper” and “Frame” settings can be changed using the “ERASE SETTING” function in the Utility mode (p. 9-36).
- 3 If necessary, specify any other copy settings.
 - 4 Using the 10-Key Pad, enter the desired number of copies, and then press the [Start] key.

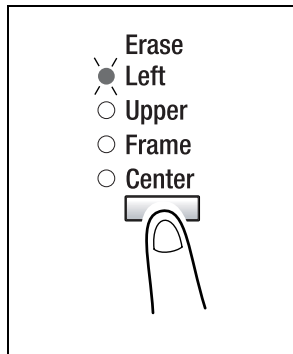

5.4 Negative/Positive Inverted Copying

Copies can be made with the light-colored areas of the document (media) and the dark-colored areas of the document (text) inverted.

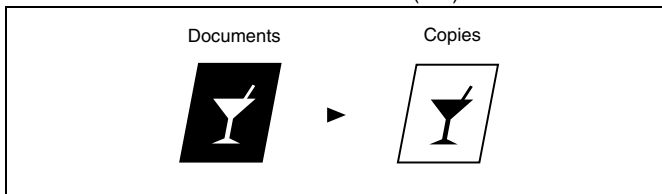

To make copies using the negative/positive inverted copy function

- 1 Load the document to be copied.
 - Refer to “Loading the Document” on page 4-1.
- 2 Press the [Neg. ↔ Pos.] key until the “Neg. ↔ Pos.” indicator lights up.

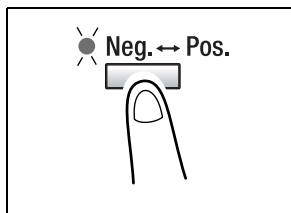

- 3 If necessary, specify any other copy settings.
- 4 Using the 10-Key Pad, enter the desired number of copies, and then press the [Start] key.

5.5 Making Copies for Filing (“File Margin” function)

So that copies can easily be stored in filing binders, copies can be made with a file margin.

Left-side binding:

Copies are printed with the contents of the document slightly shifted to the right in order to create a binding margin at the left.

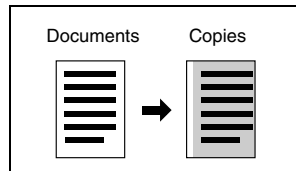

Precautions on the Binding Margin Location

Original Glass	Automatic Document Feeder

To make copies using the “File Margin” function

- 1 Load the document to be copied.
 - Refer to “Loading the Document” on page 4-1.

- 2 Press the [File Margin] key until the “File Margin” indicator lights up.

? *Do you know how large of a binding margin is created?*

- The width for the binding can be set between 0 inch (0 mm) and 3/4 inch (20 mm), in 1 mm (Approx. 1/16 inch) increments. The default setting is 1/2 inch (10 mm).
- The width of the binding margin can be changed using the “MARGIN SETTING” function in the Utility mode (p. 9-36).

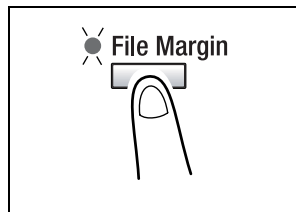

- 3 If necessary, specify any other copy settings.

- 4 Using the 10-Key Pad, enter the desired number of copies, and then press the [Start] key.

5.6 Programmed Copy Jobs

Store up to two of the more frequently used copy setting programs for immediate recall when necessary.

**Note**

Copy programs cannot be stored while the machine is warming up or while a copy job is paused (Interrupt mode).

To store a copy program

- 1 Select the copy settings to be stored as the copy program.
- 2 Press the [Job Input] key.

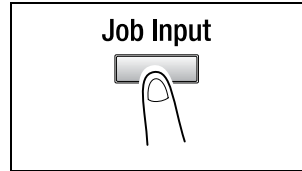

- 3 Using the ◀ and ▶ keys, select the program number where you wish to store the copy program, and then press the [Yes] key.

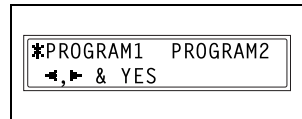
**Note**

If a copy program has already been stored under the selected program number, the previous copy settings are deleted and replaced with the new ones.

To recall a copy program

- 1 Load the document to be copied.
 - Refer to “Loading the Document” on page 4-1.
- 2 Press the [Job Recall] key.

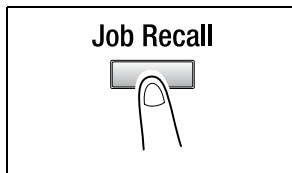

- 3 Using the ◀ and ▶ keys, select the program number of the copy program that you wish to recall, and then press the [Yes] key.

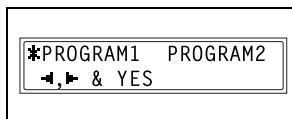

- 4 Press the [Start] key.

6 Faxing

This machine is a G3 fax. Faxes can only be sent or received with this machine if the recipient's or sender's machine complies with the G3 standard.

6.1 Document Specifications for Transmission

Using the Automatic Document Feeder

- Fed documents will be sent with a width of a Letter L-, Legal L-, or 11×17 L-size page (whichever is smallest, but still larger than the document).
- Non-standard-sized documents with a size no larger than that shown below can be fed.

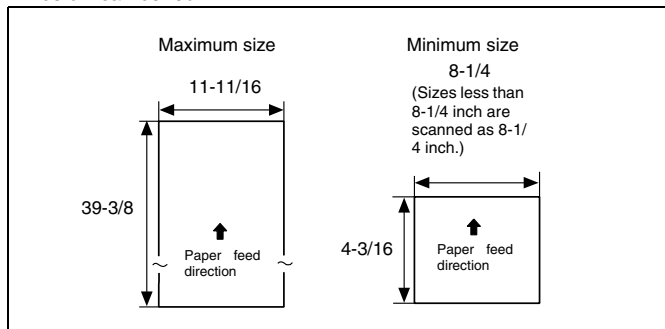

- If the length of the document exceeds $39-3/8$ inch, the machine assumes that a paper misfeed has occurred and stops scanning.
- When using the Super Fine setting to feed a document with a width of an 11×17 -size page, the document can have a length of up to $35-7/16$ inch.
- When using the Automatic Document Feeder, as many as 50 sheets of 11×17 -size plain paper can be loaded.
- The scanning area is $1/16$ inch from the leading edge to $1/16$ inch from the trailing edge of the document.

**CAUTION**

Documents with staples and paper clips attached may damage the machine.

- Be sure to remove all staples and paper clips from the document before faxing it.

Placing documents on the Original Glass

- The fax document sizes that can be set using the Control Panel are Letter L, Letter C, Legal L and 11 × 17 L. (p. 6-5)
This machine scans the scanning area for the document size that is set.

**CAUTION**

Make sure that any ink, correction fluid, etc. is completely dry before faxing the document.

Any part of the document within 1/2 inch from any side of the page cannot be scanned.

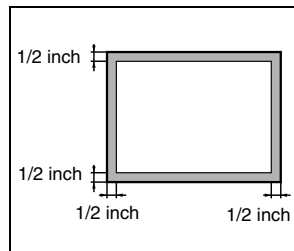

6.2 Basic Faxing

To fax using the Automatic Document Feeder

- 1 Press the [Fax] key.

The machine enters Fax mode, and the fax screen appears.

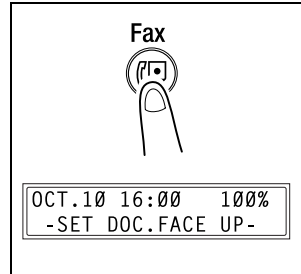

- 2 Load the document to be faxed into the Automatic Document Feeder.

- Adjust the Document Guide Plates to fit the size of the document.
- Load the document face up.

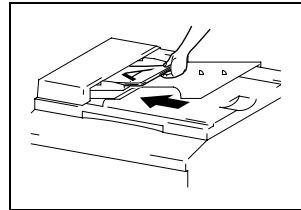

- 3 If necessary, change the "Resolution" setting (p. 6-8).

- 4 Using the 10-Key Pad, enter the fax number of the recipient.

- The fax number of a previously programmed recipient can also be specified. Refer to "Dialing" on page 6-10.

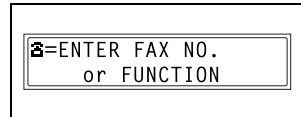

- 5 Press the [Start] key to begin scanning and sending the fax.

- To stop the transmission, press the [Stop] key.

Once transmission is finished, a beep is sounded.

If the fax could not be sent, the transmission result report is printed (p. 10-50).

**Tip**

About 390 Letter-size document pages can be scanned and stored in the memory at one time. If the optional expansion memory (8MB Memory for Fax) is installed, as many as 1,170 document pages can be stored.

If an Letter-size document page is positioned crosswise, the scanned image is rotated 90° and sent lengthwise. However, with direct transmission and manual transmission, the image is not rotated. If the image is not rotated, it is sent as a document with the width of an 11 × 17-size page.

**To cancel the transmission:**

If you wish to cancel a scanned document queued for transmission or a fax waiting to be redialed, select "CANCEL RESERV." from the "FUNCTION" menu (p. 7-19).

**About redialing:**

While faxing, if the recipient's fax machine is busy or does not answer, or if for any other reason, such as a transmission error, the fax is not sent correctly, the machine automatically redials the fax number and tries sending the fax again. If the fax could not be sent correctly after redialing, the transmission result report is printed.

To fax documents positioned on the Original Glass

1 Press the [Fax] key.

The machine enters Fax mode, and the fax screen appears.

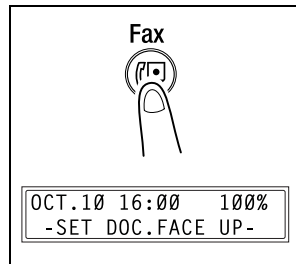

2 Lift open the Original Cover, and then position the document to be faxed on the Original Glass.

- Position the document face down.
- Align the document on the scales above and to the left of the Original Glass.
- If the Automatic Document Feeder is not installed, skip to step 4.

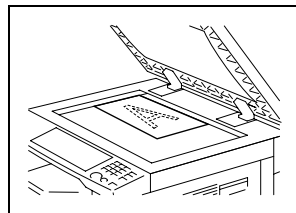

3 Press the [Book TX] key.

- Even when faxing sheet documents positioned on the Original Glass, the [Book TX] key should be pressed.

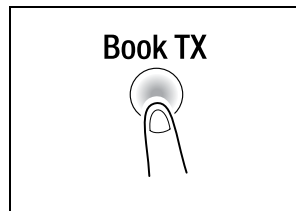

4 If necessary, change the “Resolution” setting (p. 6-8).

5 Using the 10-Key Pad, enter the fax number of the recipient, and then press the [Yes] key.

- The fax number of a previously programmed recipient can also be specified. Refer to “Dialing” on page 6-10.

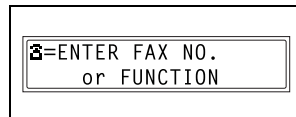

- 6** Check that the correct document size appears in the screen.
- To change the document size, press the ▼ key, and then use the ◀ and ▶ keys to select the desired document size in the screen that appears.

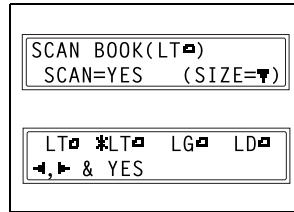

- 7** Press the [Yes] key to scan the page.

- 8** If the document to be faxed contains multiple pages, position the next page of the document on the Original Glass when the screen shown at the right appears, and then press the [Yes] key.

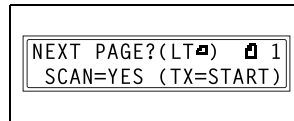

- Repeat step 8 until all pages of the document have been scanned.
- 9** Press the [Start] key to begin sending the fax.
- To stop the transmission, press the [Stop] key.
- Once transmission is finished, a beep is sounded. If the fax could not be sent, the transmission result report is printed (p. 11-3).

**Tip**

About 390 Letter-size document pages can be scanned and stored in the memory at one time. If the optional expansion memory (8MB Memory for Fax) is installed, as many as 1,170 document pages can be stored.

If an Letter-size document page is positioned crosswise, the scanned image is rotated 90° and sent lengthwise.

**To cancel the transmission:**

If you wish to cancel a scanned document queued for transmission or a fax waiting to be redialed, select "CANCEL RESERV." from the "FUNCTION" menu (p. 7-19).

**About redialing:**

While faxing, if the recipient's fax machine is busy or does not answer, or if for any other reason, such as a transmission error, the fax is not sent correctly, the machine automatically redials the fax number and tries sending the fax again. If the fax could not be sent correctly after redialing, the transmission result report is printed.

If the Memory Becomes Full While Scanning Fax Documents

If the memory becomes full while scanning a document for memory transmission, only the pages that have been scanned are sent.

With a queued transmission (a fax transmission requested while another fax transmission job is being performed) or timer transmission, if the memory becomes full while scanning the document, a message appears, allowing you to select whether to send just the scanned pages or cancel the transmission. If the transmission is cancelled, the data for the scanned pages is deleted. After the other fax transmission or reception is finished, check the amount of memory available, and then try sending the fax again.

**Note**

Depending on the recipient's fax machine, faxes sent with the Super Fine or Super Fine + Half Tone setting may not be sent as specified, and instead are sent with the Fine or Half Tone setting.

If the Half Tone or Super Fine + Half Tone setting is specified, the fax may be sent with a decreased resolution depending on the quality of the recipient's fax machine or whether the document size is larger than the paper loaded in the recipient's fax machine.

6.4 Dialing

The recipient's fax number can be dialed using any of the seven different dialing methods described below.

The procedures described below assume that the fax is being sent using the Automatic Document Feeder.



Sending international faxes:

If the country code and recipient's fax number are entered immediately after the prefix for making an international call, not enough time may be allowed for making the connection, making the fax number seem busy. If this is the case, press the [Redial/Pause] key twice before entering the country code and fax number so that there is a pause of about 6 seconds after the prefix for international calls is dialed. If a connection still cannot be made, send the fax manually (p. 7-1).

To fax by entering the fax number directly using the 10-Key Pad

- 1 Press the [Fax] key to enter Fax mode.
- 2 Load the document into the Automatic Document Feeder.
- 3 If necessary, change the “Resolution” setting (p. 6-8).

- 4 Using the 10-Key Pad, enter the fax number of the recipient.

- F codes (sub-address and SID) can also be entered. Refer to “Using F codes” on page 7-25.

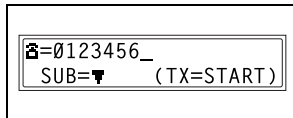

- ➔ **?** *Have you entered the number correctly?*

- ➔ The fax number can contain a maximum of 30 digits.
 - ➔ The keys that can be used to enter the fax number are: the number keys (0 through 9), *, #, -, Space, and Pause
 - ➔ If the [Redial/Pause] key is pressed while entering the fax number, a 3-second pause is added. A pause appears as “P” in the display.
 - ➔ If you wish to change the fax number, press the [No] key, and then enter the correct number.
 - ➔ If the machine is connected to a PBX line and the outside line access number has been specified in the communication settings (p. 3-35), enter “#” to dial the outside line access number automatically.
- 5 Press the [Start] key to begin scanning and sending the fax.

To fax using one-touch dialing

If one-touch dial keys have already been programmed with fax numbers, the fax number of a recipient can be specified by pressing just the corresponding one-touch dial key.

For details on programming the one-touch dial keys, refer to “Setting Up One-Touch Dialing (“ONE-TOUCH DIAL” function)” on page 10-3.

- 1 Press the [Fax] key to enter Fax mode.
- 2 Load the document into the Automatic Document Feeder.
- 3 If necessary, change the “Resolution” setting (p. 6-8).
- 4 Press the one-touch dial key ([01] through [27]) programmed with the fax number that you wish to send the fax to.

01	02	03	04	05	06	07	08	09
ABC	DEF	GHI	JKL	MNO	PQR	STU	VWX	YZ
10	11	12	13	14	15	16	17	18
abc	def	ghi	jkl	mno	pqr	stu	vwx	yz
19	20	21	22	23	24	25	26	27
@	-	-	+	-	&		␣ Space	⌫ Delete

The machine automatically starts scanning the document and sending the fax.

ONE-TOUCH DIAL 01

☎=AAA TOKYO



Tip

If the wrong one-touch dial key has been pressed, press the [Stop] key either while dialing or sending the fax to stop the transmission.

To fax using speed dialing

If speed dial numbers have already been programmed, the fax number of a recipient can be specified quickly by entering the corresponding speed dial number.

For details on programming speed dial numbers, refer to “Setting Up Speed Dialing (“SPEED DIAL” function)” on page 10-8.

- 1 Press the [Fax] key to enter Fax mode.
- 2 Load the document into the Automatic Document Feeder.
- 3 If necessary, change the “Resolution” setting (p. 6-8).

- 4 Press the [Speed Dial] key, and then use the 10-Key Pad to enter the 3-digit speed dial number.

? *Has the wrong speed dial number been entered?*

- Press the [No] key, and then enter the correct number.

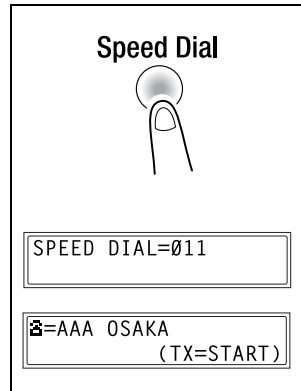

- 5 Press the [Start] key to begin scanning and sending the fax.

To fax using group dialing

If one-touch dial keys have already been programmed with a group of fax numbers, the fax numbers of all recipients in the group can be specified by pressing just the corresponding one-touch dial key.

For details on programming one-touch dial keys with a group of fax numbers, refer to “Setting Up One-Touch Dialing (“ONE-TOUCH DIAL” function)” on page 10-3.

- 1 Press the [Fax] key to enter Fax mode.
- 2 Load the document into the Automatic Document Feeder.
- 3 If necessary, change the “Resolution” setting (p. 6-8).
- 4 Press the one-touch dial key ([01] through [27]) programmed with the group of fax numbers that you wish to send the fax to.

The machine automatically starts scanning the document and sending the fax.

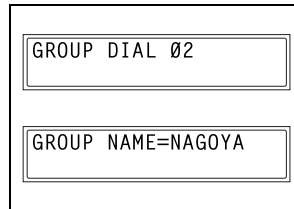

Tip

If the wrong one-touch dial key has been pressed, press the [Stop] key either while dialing or sending the fax to stop the transmission.

To fax using program dialing

If one-touch dial keys have already been programmed with fax numbers and a transmission/reception function (such as timer transmission or polling reception), that function can be carried out by pressing just the corresponding one-touch dial key.

For details on setting program dialing, refer to “Setting Up Program Dialing (“PROGRAM DIAL” function)” on page 10-16.

- 1 Press the [Fax] key to enter Fax mode.
- 2 Load the document into the Automatic Document Feeder. (This step is not necessary with polling reception.)
- 3 If necessary, change the “Resolution” setting (p. 6-8). (This step is not necessary with polling reception.)
- 4 Press the one-touch dial key ([24] through [27]) programmed with the desired function.

The programmed function automatically begins.

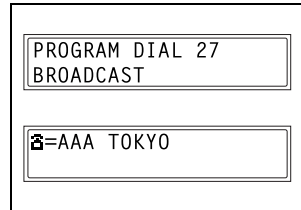

Tip

If the wrong one-touch dial key has been pressed, press the [Stop] key either while dialing or sending the fax to stop the operation.

To cancel a timer transmission, select “CANCEL RESERV.” from the “FUNCTION” menu (p. 7-19).

To fax using combination dialing

If one-touch dial keys or speed dial numbers have already been programmed with special prefix numbers, a fax number can be specified by recalling the prefix number from the one-touch dial key or speed dial number, and combining it with the fax number of a recipient either entered using the 10-Key Pad or recalled from a one-touch dial key or speed dial number.

For example, if the phone number and the extension number of a recipient are programmed in different one-touch dial keys, the fax number of the recipient can be specified by combining the two numbers.

A maximum of 30 digits (excluding “+”) can be dialed.

For details on programming combination dialing numbers, refer to page 10-3 and page 10-8.

- 1 Press the [Fax] key to enter Fax mode.
- 2 Load the document into the Automatic Document Feeder.
- 3 If necessary, change the “Resolution” setting (p. 6-8).

- 4 Press the one-touch dial key ([01] through [27]) programmed with the desired combination dialing number.

or

Press the [Speed Dial] key, and then use the 10-Key Pad to enter the 3-digit speed dial number.

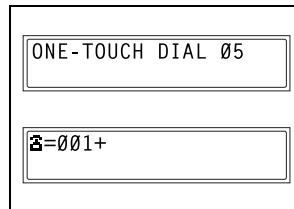

- 5 Use the 10-Key Pad to enter the remainder of the fax number, and then press the [Start] key.

- The remainder of the fax number can also be specified using the one-touch dial keys or the speed dial numbers. If it is specified using the one-touch dial keys, the machine automatically starts scanning the document and sending the fax.

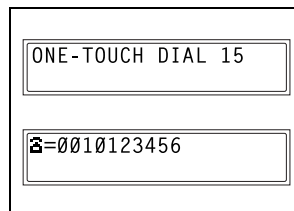

To fax using the phone book

The phone book contains all programmed one-touch dialing and speed dialing numbers, allowing you to search for and select the recipient that you wish to send the fax to.

- 1 Press the [Fax] key to enter Fax mode.
- 2 Load the document into the Automatic Document Feeder.
- 3 If necessary, change the “Resolution” setting (p. 6-8).
- 4 Press the [Phone Book] key.

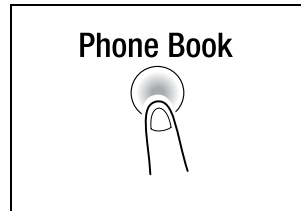

- 5 Using the ◀ and ▶ keys, select either “LIST” or “SEARCH”, and then press the [Yes] key.
 - If “LIST” was selected:
The list of programmed one-touch dialing and speed dialing numbers is displayed. Using the ▲ and ▼ keys, select the desired recipient.
 - If “SEARCH” was selected:
A screen appears, allowing you to enter the text to be searched for. Search for the desired recipient by entering part (or all) of the name programmed. For details on performing the search, refer to “To search the phone book” on page 6-18.
- 6 Press the [Start] key to begin scanning and sending the fax.



To search the phone book

1 Press the [Phone Book] key.

2 Using the ◀ and ▶ keys, select “SEARCH”, and then press the [Yes] key.

A screen appears, allowing you to enter the text to be searched for.

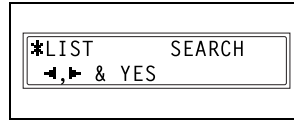

3 Using the one-touch dial keys, enter the first few characters of the name programmed for the desired recipient.

- Enter the name programmed in the one-touch dial key or the speed dial number. (For details on entering text, refer to “Entering Text” on page 3-36.)
- From 1 to 10 characters can be entered.

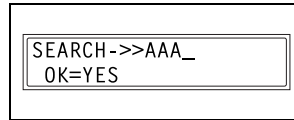

4 Press the [Yes] key.

The number of names beginning with the text entered in step 3 is displayed.

To select a recipient from the displayed search results, skip to step 7.

? *Are there no one-touch dialing or speed dialing numbers with names beginning with the entered text?*

→ After “(0)” is displayed, the screen allowing you to enter the search text appears.

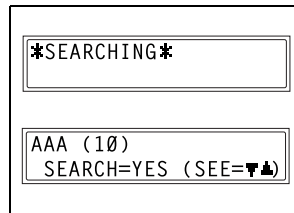

5 To narrow down the search results even further, press the [Yes] key, and then enter more search text.

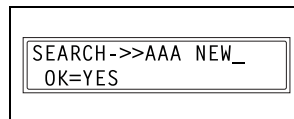

6 Press the [Yes] key.

- 7 Using the ▲ and ▼ keys, select the desired recipient.

- If the desired recipient name does not appear in the search results, press the [No] key to return to the screen allowing you to enter the search text, and then try searching for different text.

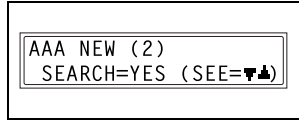

- 8 Press the [Start] key to begin scanning and sending the fax.



To redial the last recipient called

- 1 Press the [Fax] key to enter Fax mode.
- 2 Load the document into the Automatic Document Feeder.
- 3 If necessary, change the “Resolution” setting (p. 6-8).
- 4 Press the [Redial/Pause] key.

The fax number of the last recipient called is displayed.

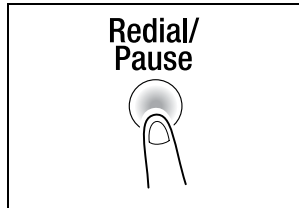

- 5 Press the [Start] key to begin scanning and sending the fax.

6.5 Receiving

Receiving Automatically/Manually

If the machine is set to receive faxes automatically, no further operations are required.

If the machine is set to receive faxes manually, the telephone receiver must be picked up in order to receive the fax.

For details on changing the reception method, refer to "To set the "RX MODE" function" on page 10-45.

Receiving

- While receiving:
 - The mark indicating that a fax is being received appears in the display.

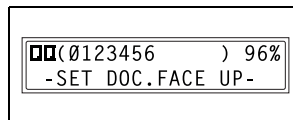

- Once reception is finished, a beep is sounded.

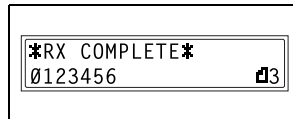

- For details on checking the transmission result, refer to page 6-22.
- If there is no more paper:

If the "AUTO SELECT" paper supply setting is selected, the paper tray containing paper of the same size is automatically selected, and the fax is printed. If there is no tray containing paper of the same size, the following occurs.

 - The message "PAPER EMPTY" appears in the display.
 - The received fax is stored in the memory, and when paper of the appropriate size is loaded, the fax is automatically printed.
 - If the entire fax does not fit in the memory, the remainder of the document is not received.
 - If the memory becomes full, no more documents can be received.

- Paper sizes of received faxes
 - The sizes of documents that can be received are 11 × 17 L, Letter L, Letter C, Legal L and Invoice C.
 - If paper of the same size as the document is not loaded in a paper tray, the fax is printed on paper of a larger size. For example, if Letter-size paper is not loaded into a paper tray, a Letter-size received fax will be printed on Legal- or 11 × 17-size paper. (If 11 × 17- or Legal-size paper is not loaded into a paper tray, the fax is regarded as one compatible with Letter-size paper.)
 - Received faxes cannot be printed on paper in the Manual Bypass Tray.
- Long documents that are received
 - If a long document (as compared with standard sizes such as Letter and Legal) is received, the length is automatically reduced to fit within a single sheet of paper.
 - The length is reduced to a maximum of 70%, and then printed. If the document does not fit within a single sheet of paper, even after reducing it to 70%, the document is divided and printed so that the ends overlap.

In addition, the machine can be set to divide the document without reducing it or to discard any excess. (Refer to “To set the “REDUCTION RX” function” on page 10-44.)
 - If the paper size units are set to “METRIC” for any paper tray, a received document cannot be printed onto paper loaded into that tray. (Refer to “To specify the automatic paper size detection units (“INCH/METRIC” function)” on page 9-13.)
 - If any of the following settings are specified for the 1st Tray, a received document cannot be printed onto paper loaded into that tray. (Refer to “To specify the size of paper loaded into the 1st Tray (“TRAY1 PAPER” function)” on page 9-14.)
 - When the paper type is set to “OHP” or “CARD”
 - When the paper size is set to “SIZE INPUT”

6.6 Checking Transmission Results

The transmission result information for a maximum of 60 sent and received documents is saved.

To check the transmission result

- 1 Press the [Confirm] key.

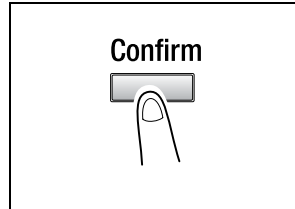

- 2 Press the [Yes] key.

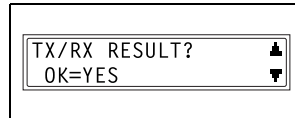

- 3 Using the ▲ and ▼ keys, display the desired transmission results to check them.

- In the transmission result screen, "TX" indicates sent faxes, and "RX" indicates received ones.
- If the [No] key is pressed twice while the transmission results are displayed, the main screen appears.
- To print the transmission result report, press the [Start] key. After the transmission result report is printed, the main screen appears.

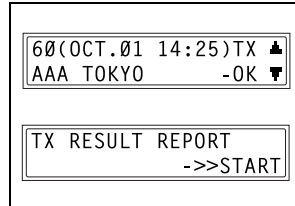

7 Fax Transmission/Reception Methods

7.1 Transmission Methods

Memory Transmission

With memory transmission, the document is scanned, then stored in the memory for transmission (queued transmission).

Memory transmission is selected as the default transmission mode.

For details on sending faxes through memory transmission, refer to “Basic Faxing” on page 6-3.

Book Transmission

Press the [Book TX] key when faxing documents (not limited to books) positioned on the Original Glass.

For details on faxing book documents, refer to the section “To fax documents positioned on the Original Glass” on page 6-5 of “6 Basic Faxing”.

Manual Transmission

If the machine is connected to a telephone and the same line is used for phoning and faxing, the document can simply be sent after talking with the recipient over the phone.

This is useful, for example, if you wish to tell the recipient that you are sending a fax.



Note

If the recipient's fax machine is set to receive faxes automatically (automatic reception), a beep is sounded without the recipient answering the phone; however, at that time, the telephone cannot be used for talking.

If the fax is to be sent after talking on the telephone, use the Automatic Document Feeder.

Manual transmission is possible if a telephone (either purchased or rented) is connected to the TEL port of this machine.

**Tip**

Even when pulse dialing is being used, entering “x” produces signals for tone dialing.

To send a fax manually

1 Load the document into the Automatic Document Feeder.

2 If necessary, change the “Resolution” setting (p. 6-8).

3 Pick up the telephone receiver.

- Check that the dial tone can be heard.

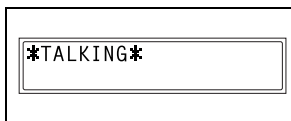

4 Specify the fax number of the recipient.

- Use the telephone to dial the fax number.
- The fax number of the recipient can also be specified using the keys in the Control Panel of this machine (p. 6-10).

5 After finishing talking on the phone, the recipient should press the necessary key to start receiving the fax.

Once the recipient's fax machine is ready, a beep is sounded.

6 Press the [Start] key to begin scanning and sending the fax.

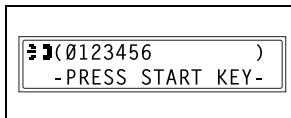

7 Replace the telephone receiver.

- To stop the transmission, press the [Stop] key.

**Tip**

If the [Speaker] key is pressed instead of picking up the telephone receiver, the speaker can be used for manual transmission in the same way as described above.

Batch Transmission

Multiple documents can be stored in the memory and faxed together at a specified time. In order to use this function, the corresponding Utility mode function must first be used to program a one-touch dial key with the batch transmission settings (transmission time) (p. 10-4).

To fax using batch transmission

- 1 Load the document into the Automatic Document Feeder.
- 2 If necessary, change the “Resolution” setting (p. 6-8).
- 3 Press the one-touch dial key programmed with the desired batch transmission settings.

The machine automatically starts scanning the document, then automatically sends it at the specified time.

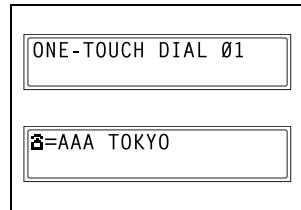

Tip

To cancel a batch transmission, select “CANCEL RESERV.” from the “FUNCTION” menu (p. 7-19).

Broadcast Transmission

The same document can be sent to multiple recipients at one time.

A maximum of 143 recipients can be specified for the same transmission.

The recipients can be specified by using the one-touch dial keys, the speed dial numbers or group dialing, by selecting from the phone book, or by entering the fax number using the 10-Key Pad.



Note

A maximum of 16 recipients can be specified by entering the fax number using the 10-Key Pad.



Tip

With the result report printed after the transmission is finished, you can check whether the fax was sent to all recipients.

To fax using broadcast transmission

- 1 Position the document to be faxed.
- 2 If necessary, change the "Resolution" setting (p. 6-8).
- 3 Press the [Function] key.

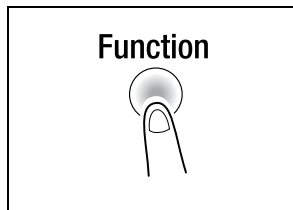

- 4 Press the [1] key from the 10-Key Pad.
or
Press the [Function] key once to select "BROADCAST", and then press the [Yes] key.

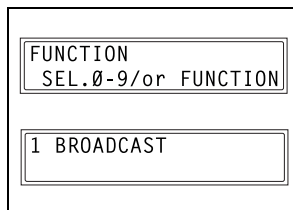

5 Specify the fax number of the recipient.

Repeat the appropriate operations described below until all recipients have been specified.

- When using the one-touch dial keys:

Press the one-touch dial key programmed with the desired fax number.

Press the [Yes] key, and then specify the next recipient.

NO.001=ONE-TOUCH 01

NO.001=AAA TOKYO
OK=YES (Fin.=START)

- When using the speed dial numbers:

Press the [Speed Dial] key, and then use the 10-Key Pad to enter the 3-digit speed dial number programmed with the desired fax number.

Press the [Yes] key, and then specify the next recipient.

NO.002=SPEED 011

NO.002=AAA OSAKA
OK=YES (Fin.=START)

- When using group dialing:
Press the one-touch dial key programmed with the desired group of fax numbers.
Press the [Yes] key, and then specify the next recipient.
- When selecting from the phone book:
Press the [Phone Book] key, and then select either "LIST" or "SEARCH" to select the desired fax number. (Refer to "To fax using the phone book" on page 6-17.)
Press the [Yes] key, and then specify the next recipient.

- When entering the number using the 10-Key Pad:
Enter the fax number of the recipient.

Press the [Yes] key, and then specify the next recipient.

NO.003=0123456_
OK=YES (SUB=▼)

? *Has the wrong fax number been specified?*

- Press the [No] key to delete the current selection. (This is valid only before the recipient is set by pressing the [Yes] key.)

6 Press the [Start] key.

A message appears, allowing you to select whether or not to check the recipients.

7 To check the recipients, press the [Yes] key.

- If you do not wish to check the recipients, skip to step 9.

CHECK DESTINATIONS?
OK=YES (TX=START)

8 The recipients specified in step 5 are displayed in the order that they were selected.

Check the recipient, and then press the [Yes] key.

- To delete the displayed recipient, press the [No] key.

After all recipients have been checked, "Fin.=START" appears in the display.

NO.001=AAA TOKYO
OK=YES (DEL=NO)

NO.001 DELETED

NO.005=_
(Fin.=START)

9 Press the [Start] key to begin scanning and sending the fax.

Timer Transmission

A document can be scanned and stored in the memory to be sent at a specified time. This function is convenient for sending documents with a large number of pages at discounted calling times.



Note

The time is set for a 24-hour period.

If the machine is not programmed with the current time (p. 3-31), the fax cannot be sent at the specified time.

A timer transmission cannot be performed at the same time as a direct transmission.



Tip

Timer transmission can be combined with broadcast transmission, mailbox transmission, polling reception, or relay initiation transmission.

To fax using timer transmission

- 1 Position the document to be faxed.
- 2 If necessary, change the "Resolution" setting (p. 6-8).
- 3 Press the [Function] key.

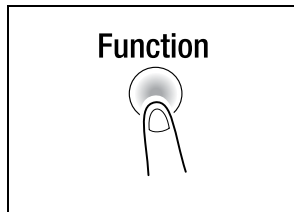

- 4 Press the [2] key from the 10-Key Pad.
or
 Press the [Function] key twice to select "TIMER TX", and then press the [Yes] key.

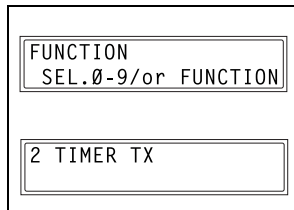

A screen appears, allowing you to specify the transmission time.

- 5** Using the 10-Key Pad, enter the desired transmission time, and then press the [Yes] key.

- If you wish to correct the time, press the [No] key, and then enter the correct time.

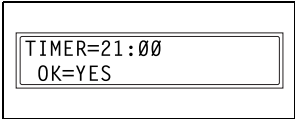

TIMER=21:00
OK=YES

- 6** Specify the fax number of the recipient.

- Refer to "Dialing" on page 6-10.

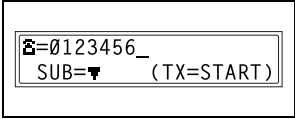

☎=0123456_
SUB=▼ (TX=START)

- 7** Press the [Start] key.

The machine scans the document, then enters transmission standby mode.

Mailbox Transmission

The fax can be sent to a recipient's mailbox.

This is perfect for sending an important document to a specific person.



Note

Mailbox transmission is compatible with F code transmission.

Machines compatible with F codes can be specified as recipients for mailbox transmission.

To fax using mailbox transmission

- 1 Position the document to be faxed.
- 2 If necessary, change the "Resolution" setting (p. 6-8).
- 3 Press the [Function] key.

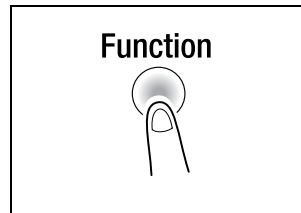

- 4 Press the [3] key from the 10-Key Pad.
or
Press the [Function] key 3 times to select "MAILBOX TX", and then press the [Yes] key.

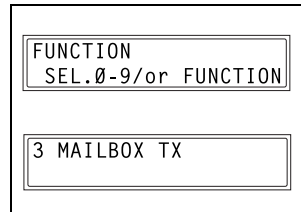

- 5 Specify the recipient, and then press the [Yes] key.
 - Refer to "Dialing" on page 6-10. A screen appears, allowing you to specify the mailbox ID.

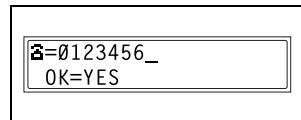

6 Using the 10-Key Pad, enter the mailbox ID of the recipient.

- Enter the mailbox ID (SUB) (20 digits or less) registered for the recipient.
- If the recipient is specified using a one-touch dial key or a speed dial number also programmed with a sub-address, the sub-address is displayed as the mailbox ID. If necessary, change the mailbox ID.
- If you wish to correct the mailbox ID, press the [No] key, and then enter the new number.



MAILBOX ID=1234
OK=YES

7 Press the [Yes] key.

8 Using the 10-Key Pad, enter the password.

- Enter the password (20 digits or less) if a password has been set for the recipient's mailbox.
- If you wish to correct the password, press the [No] key, and then enter the new number.

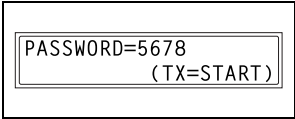

PASSWORD=5678
(TX=START)

9 Press the [Start] key to begin scanning and sending the fax.

Relay Initiation Transmission

Documents can be sent from this machine (transmitting station) to another fax machine (acting as a relay station), which then sends the documents to multiple recipients (receiving stations). By relaying the documents through a fax machine closer to the remote recipients, the transmission time and cost for the transmitting station are reduced.

In order to fax using relay initiation transmission, a relay box must first be programmed at the relay station.



Note

Relay initiation transmission is compatible with F code transmission. Only machines that are compatible with relay broadcast transmission should be specified as relay stations. This machine can be specified as a relay station.

Relay initiation transmission and mailbox transmission cannot be performed at the same time.

In order to fax using relay initiation transmission, a relay box ID must first be programmed at the relay station (p. 10-31).

To fax using relay initiation transmission

- 1 Position the document to be faxed.
- 2 If necessary, change the “Resolution” setting (p. 6-8).
- 3 Press the [Function] key.

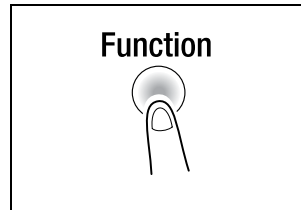

- 4 Press the [7] key from the 10-Key Pad.
or
Press the [Function] key 7 times to select “RELAY INITIATE”, and then press the [Yes] key.

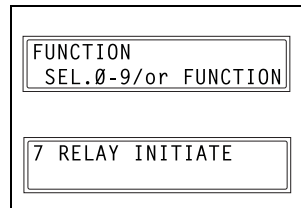

- 5** Specify the relay station, and then press the [Yes] key.

- Refer to “Dialing” on page 6-10. A screen appears, allowing you to specify the relay box ID.

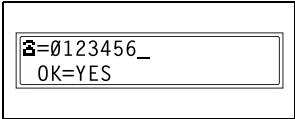

3=0123456_
OK=YES

- 6** Using the 10-Key Pad, enter the relay box ID.

- Enter the relay box ID (20 digits or less) programmed at the relay station.
- If you wish to correct the ID, press the [No] key, and then enter the new number.

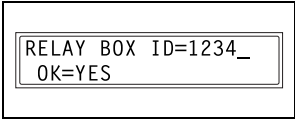

RELAY BOX ID=1234_
OK=YES

- 7** Press the [Yes] key.

A screen appears, allowing you to specify the password.

- 8** Using the 10-Key Pad, enter the password.

- Enter the password (20 digits or less) if a password has been set at the relay station.
- If you wish to correct the password, press the [No] key, and then enter the new number.

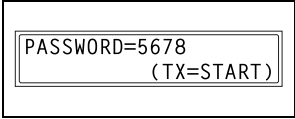

PASSWORD=5678
(TX=START)

- 9** Press the [Start] key to begin scanning and sending the fax.

Relay Broadcast Transmission

If this machine is specified as a relay station, it can receive documents sent from another fax machine (transmitting station), then send the documents to multiple recipients (receiving stations).

In order to fax using relay broadcast transmission, a relay box must first be programmed. A maximum of 5 relay boxes can be programmed. For details on programming a relay box, refer to “Setting Up Relay Boxes (“RELAY BOX” function)” on page 10-31.



Note

Relay broadcast transmission is compatible with F code transmission. In order for the machine to function as a relay station, a 4-digit relay box ID must first be programmed (p. 10-31).

In order to fax using relay broadcast transmission, the receiving stations (final recipients) must be programmed in a relay box (p. 10-31).

The document is printed at the receiving stations.

Direct Transmission

If direct transmission is specified, one page of the document at a time can be scanned, according to the transmission status. This ensures that even documents with many pages can be sent.



Note

When faxing using direct transmission, the document should be loaded into the Automatic Document Feeder. Transmission is not possible by positioning the document on the Original Glass.
If direct transmission is specified while a fax is being sent or received, the transmission will be queued.
With direct transmission, multiple recipients cannot be specified.
Direct transmission and timer transmission cannot be performed at the same time.

To fax using direct transmission

- 1 Load the document into the Automatic Document Feeder.
- 2 Press the [Function] key.

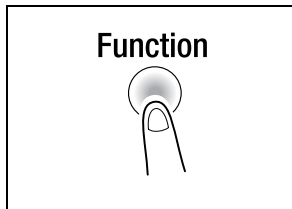

- 3 Press the [9] key from the 10-Key Pad.
or
 Press the [Function] key 9 times to select "TX MODE", and then press the [Yes] key.

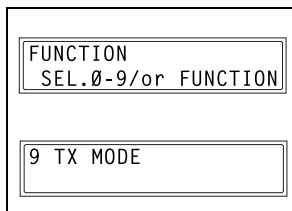

- 4 Using the ◀ and ▶ keys, select "ADF TX", and then press the [Yes] key.

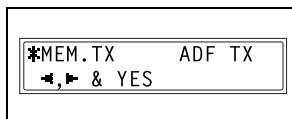

- 5 If necessary, change the "Resolution" setting (p. 6-8).
- 6 Specify the fax number of the recipient.

- Refer to "Dialing" on page 6-10.

☎=0123456_
SUB=▼ (TX=START)

- 7 Press the [Start] key to begin scanning and sending the fax.

**Note**

When transmission is finished, the transmission mode returns to the default setting.

Memory transmission is the default transmission mode. To keep the transmission mode set to direct transmission, set Utility mode function "DEFAULT TX" to "ADF TX" (p. 10-38).

Polling Transmission

Documents scanned and saved in the memory can be retrieved by the recipient.



Note

Polling transmission is compatible with F code transmission.

If the memory is full, polling transmission cannot be set.

With polling transmission, the recipient incurs the cost of the call.

To set up polling transmission

- 1 Position the document to be faxed.
- 2 If necessary, change the "Resolution" setting (p. 6-8).
- 3 Press the [Function] key.

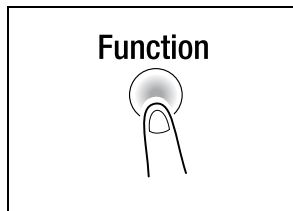

- 4 Press the [5] key from the 10-Key Pad.

or

Press the [Function] key 5 times to select "POLLING TX", and then press the [Yes] key.

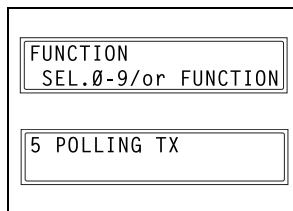

- 5 Using the ◀ and ▶ keys, select either "SINGLE" or "MULTI", and then press the [Yes] key.

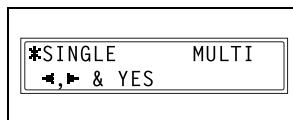

- To allow only one polling transmission request, then delete the document from the memory, select "SINGLE".
- To allow multiple polling transmission requests, select "MULTI". The document is stored in the memory until it has been deleted.

- 6** Using the 10-Key Pad, enter the 4-digit polling ID, and then press the [Yes] key.

- If you do not wish to set a polling ID, skip to step 8.
- The polling ID can be set to any number between 0000 and 9999.



POLLING ID=1234
OK=YES

- 7** Using the 10-Key Pad, enter the 4-digit password.

- If you do not wish to set a password, continue with step 8.
- The password can be set to any number between 0000 and 9999.

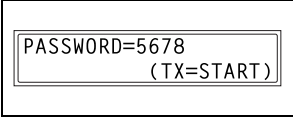

PASSWORD=5678
(TX=START)

- 8** Press the [Start] key.

The machine scans the document, then enters standby mode.

To delete a document from the polling transmission setup

- 1 Press the [Function] key.

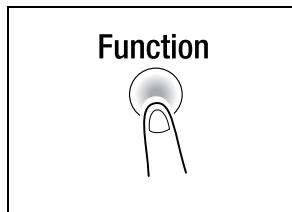

- 2 Press the [5] key from the 10-Key Pad.

or

Press the [Function] key 5 times to select "POLLING TX", and then press the [Yes] key.

If polling transmission has been set, a screen appears, allowing you to specify the polling ID.

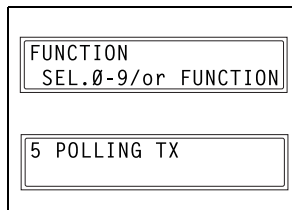

- 3 Using the 10-Key Pad, enter the polling ID, and then press the [Yes] key.

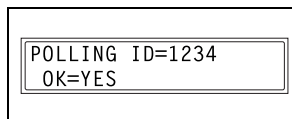

- 4 Press the [No] key to delete from the memory the document set for polling transmission.

- To keep the polling transmission setting, press the [Yes] key.

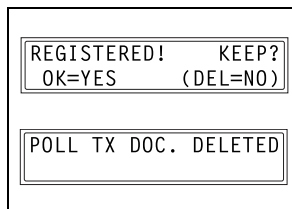

- 5 Press the [No] key twice to return to the main screen.

Cancelling (Deleting) a Document Queued in the Memory for Transmission

Of the documents stored in the memory and waiting to be sent, a specific document can be selected and deleted.

To cancel a queued document

- 1 Press the [Function] key.

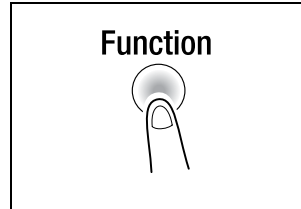

- 2 Press the [8] key from the 10-Key Pad.

or

Press the [Function] key 8 times to select "CANCEL RESERV.", and then press the [Yes] key.

The details (specified transmission time/type of transmission) of the jobs queued in the memory are displayed.

? *Have no jobs been queued in the memory?*

→ The message "NONE" appears.

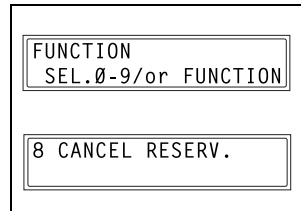

- 3 Using the ▲ and ▼ keys, select the job to be deleted.

- The following types of job are displayed.

MEMORY: Memory transmission

B-CAST: Broadcast transmission

TIMER: Timer transmission

M.B. TX: Mailbox transmission

POLL-TX: Polling transmission

POLL-RX: Polling reception

RELAY: Relay initiation transmission or relay broadcast transmission

FORWARD: Fax forwarding

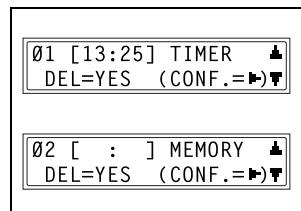

- To check the recipient of the currently displayed transmission job, press the ► key. After checking, press the [Yes] key to return to the previous screen.

- 4** Press the [Yes] key to delete the displayed job.
“CANCEL RESERV.” appears in the display.

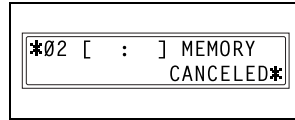

- 5** To delete another queued job, press either the [Yes] key or the [8] key, and then repeat steps 3 and 4.
- If you are finished deleting jobs, press the [No] key to return to the main screen.

7.2 Reception Methods

Manual Reception

This machine normally receives faxes automatically. However, if a telephone is connected and the same line is used for phoning and faxing, the document can simply be received after talking with the caller over the phone.



Note

Manual reception is possible if a telephone is connected to the TEL port of this machine.

To receive faxes manually, use the corresponding Utility mode function to select the manual reception mode (p. 10-42).

To receive a fax manually

- 1 After the telephone rings, pick up the receiver to talk with the caller.
- 2 After talking and the caller's fax machine sounds long beeps, press the [Start] key.

The machine starts receiving the fax.

? *Were the long beeps not sounded by the caller's fax machine?*

→ If the caller's fax machine is set to send automatically, the long beeps may not be sounded.

- 3 If the telephone receiver is replaced, the fax reception is finished and the machine sounds a beep.

Memory Reception

This machine automatically prints faxes that it has received. However, when receiving confidential faxes, the received document can be stored in the memory and printed at a specified time or when memory reception is turned off.

Memory reception is set using the corresponding Utility mode function. For details on changing the setting, refer to "To select the memory reception mode ("MEMORY RX MODE" function)" on page 10-42.

Mailbox Reception

If mailbox numbers and F codes (mailbox IDs and passwords) have already been programmed on this machine, this function can be used to receive only those faxes with an identical mailbox ID and password specified by the caller.

Since the received fax can only be retrieved after entering the corresponding mailbox ID, confidential faxes can safely be sent and received.

For details on programming the mailboxes, refer to “Setting Up Mailboxes (“MAILBOX” function)” on page 10-29.

To retrieve a document from a mailbox

- 1 Press the [Function] key.

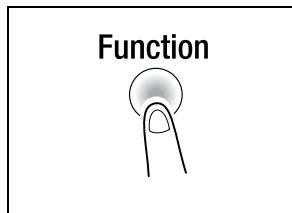

- 2 Press the [4] key from the 10-Key Pad.

or

Press the [Function] key 4 times to select “PRINT MAILBOX RX”, and then press the [Yes] key.

A screen appears, allowing you to enter the mailbox ID.

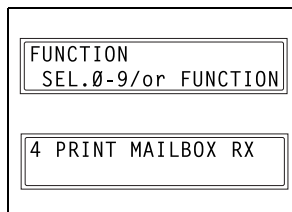

- 3 Using the 10-Key Pad, enter the 4-digit mailbox ID, and then press the [Yes] key.

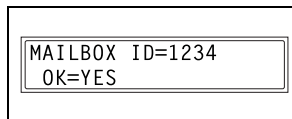

Polling Reception

Using polling reception, documents set up in other fax machines can be received.



Note

Polling reception is compatible with F code transmission.

To receive a fax using polling reception

- 1 Press the [Function] key.

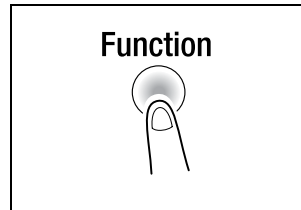

- 2 Press the [6] key from the 10-Key Pad.
or
Press the [Function] key 6 times to select "POLLING RX", and then press the [Yes] key.

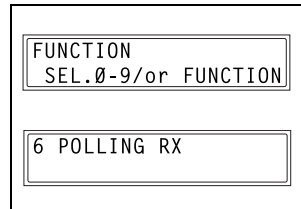

- 3 Specify the fax number to be called, and then press the [Yes] key.
 - Refer to step 5 of "To fax using broadcast transmission" on page 7-4.

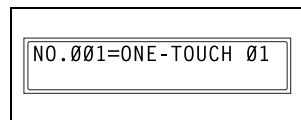

- 4 To enter the polling ID and password, press the ▼ key.
 - If there is no need to enter a polling ID and password, skip to step 7.

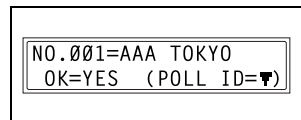

- 5** Using the 10-Key Pad, enter the polling ID (20 digits or less), and then press the [Yes] key.

POLLING ID=1111_
OK=YES

- 6** Using the 10-Key Pad, enter the password (20 digits or less), and then press the [Yes] key.

PASSWORD=2222
OK=YES

- 7** To specify multiple fax numbers, repeat steps 3 through 6.

- If you do not wish to specify other fax numbers, continue with step 8.

NO.002=
(Fin.=START)

- 8** Press the [Start] key.

A message appears, allowing you to select whether or not to check the fax numbers to be called.

- 9** To check the numbers to be called, press the [Yes] key.

- If you do not wish to check the numbers to be called, skip to step 11.

CHECK DESTINATIONS?
OK=YES (RX=START)

- 10** The fax numbers specified in step 3 are displayed in the order that they were selected.

Check the fax numbers, and then press the [Yes] key.

- To delete the displayed fax number, press the [No] key.
- After all fax numbers have been checked, "Fin.=START" appears in the display.

NO.001=AAA TOKYO
OK=YES (DEL=NO)

NO.001 DELETED

NO.002=
(Fin.=START)

- 11** Press the [Start] key.

7.3 Using F codes

This machine is compatible F code transmissions.

F codes are mailbox functions, such as “SUB” (sub-addresses), “SEP” (selective polling), “SID” and “PWD” (passwords), regulated by the G3 standards of the ITU-T (International Telecommunication Union). Mailbox transmission and reception is possible only with similar machines compatible with F code transmission. Using the 10-Key Pad, the following F codes can be set, depending on the use.

F codes

- SUB:
Specify when transmitting while using F codes.
- PASSWORD (SID):
Specify when limiting the recipient/caller with a password.
- POLL ID (SEP):
Specify when calling another fax machine to receive a document set up in it (polling reception).



Note

If one-touch dial keys or speed dial numbers are programmed with F codes (sub-addresses and SID), the appropriate F code can quickly be transmitted to the recipient/caller.

Using Mailboxes

Specifying mailboxes:

Mailboxes can be used if they are set up using the corresponding Utility mode function. Refer to "Mailbox Reception" on page 7-22.

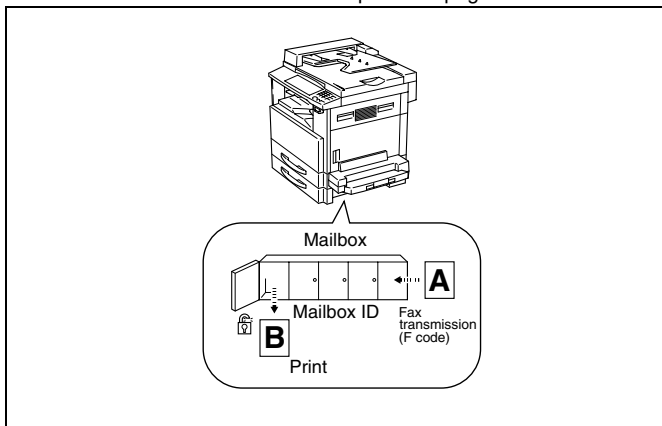

F code mailbox transmission/reception:

A maximum of 10 mailboxes can be set up. Since a mailbox ID is required in order to retrieve documents received in the different mailboxes, confidential faxes can safely be sent and received. Refer to "Setting Up Mailboxes ("MAILBOX" function)" on page 10-29.

If one-touch dial keys or speed dial numbers are programmed with F codes, the appropriate F code can quickly be transmitted. Refer to "Mailbox Transmission" on page 7-9.

Specifying F codes

When sending faxes

F codes can be specified when the 10-Key Pad is being used to enter the fax number of a recipient while sending a fax.

- 1 Using the 10-Key Pad, enter the fax number of the recipient.

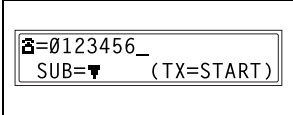

0123456_
SUB=▼ (TX=START)

- 2 Press the ▼ key, and then use the 10-Key Pad to enter the sub-address.

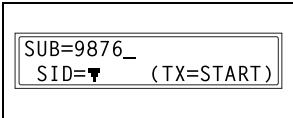

SUB=9876_
SID=▼ (TX=START)

- A number up to 20 digits long can be entered for the sub-address.
- To enter an SID, continue with step 3.
- If an SID will not be entered, continue with step 4.

- 3 Press the ▼ key, and then use the 10-Key Pad to enter the SID.

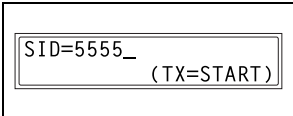

SID=5555_
(TX=START)

- A number up to 20 digits long can be entered for the SID.

- 4 Press the [Start] key to begin scanning and sending the fax.

Programming recipients

F codes can be specified when programming one-touch dial keys or speed dial numbers.

- 1** Using the 10-Key Pad, enter the fax number of the recipient.

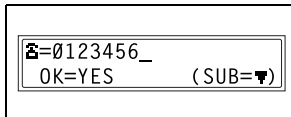

F=0123456_
OK=YES (SUB=▼)

- 2** Press the ▼ key, and then use the 10-Key Pad to enter the sub-address.

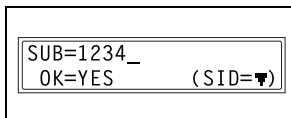

SUB=1234_
OK=YES (SID=▼)

- A number up to 20 digits long can be entered for the sub-address.
- To enter an SID, continue with step 3.
- If an SID will not be entered, continue with step 4.

- 3** Press the ▼ key, and then use the 10-Key Pad to enter the SID.

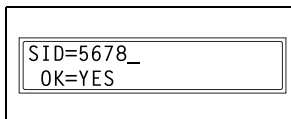

SID=5678_
OK=YES

- A number up to 20 digits long can be entered for the SID.

- 4** Press the [Yes] key. Then, continue specifying other program settings.

8 Expanded Functions by Connecting a Computer

8.1 Setting Up for PC Faxing/PC Scanning

If commercially available LaserFAX or WinFax Pro V.10.0 is installed on the computer, this machine can be used for PC faxing.

If used for PC faxing, this machine functions as a fax/modem. Using PC fax software, transmission at 14400 bps between this machine and the computer is possible. Connect the computer using a 9-pin RS232C interface cable (purchased separately).

Modem Specifications

The protocol specifications for this machine are as follows.

- Standard: EIA-578 class 1 fax/modem (does not include data modem)

8.2 Setting Up for PC Scanning

If the enclosed TWAIN Driver is installed on the computer, this machine can be used for PC scanning.

For PC scanning, an environment that includes the following software and equipment is required.

- Operating system: Windows 95, Windows 98, Windows Me, Windows NT 4.0, or Windows 2000
- TWAIN-compatible image-processing software (such as, Adobe Photoshop)
- 9-pin RS232C interface cable

For details, refer to the instruction manual included with the TWAIN Driver.

9 Utility Mode – Copy Functions

This chapter describes the various Utility mode functions that can be used to set copy-related functions.

**Note**

Depending on the options installed, some functions may not be available. If an unavailable function is selected, an error message appears.

9.1 Specifying Machine Settings (“MACHINE SETTING” Menu)

From the “MACHINE SETTING” menu, various functions of the machine’s operating environment can be set.

“MACHINE SETTING” menu:

No.	MACHINE SETTING	Description
1	AUTO PANEL RESET	This function can be used to set the length of time until the Control Panel automatically returns to its default settings after copying or the last operation is finished. <ul style="list-style-type: none"> The manufacturer’s default setting is 1 min.
2	ENERGY SAVE MODE	This function can be used to set the length of time until the machine automatically enters Energy Saver mode after the last operation is finished. <ul style="list-style-type: none"> The manufacturer’s default setting is 15 min.
3	AUTO SHUT OFF	This function can be used to set the length of time until the machine automatically turns off after the last operation is finished. <ul style="list-style-type: none"> The manufacturer’s default setting is “OFF” (no auto power-off).
4	DENSITY (ADF)	This function can be used to set the image quality when scanning using the Automatic Document Feeder (ADF). Select “MODE1” when scanning normal documents (such as documents created on a word processor), or select “MODE2” when reproducing faint documents. This function is only available when the Automatic Document Feeder is installed. <ul style="list-style-type: none"> The manufacturer’s default setting is “MODE1”.
5	PRINT DENSITY	The print density can be set to one of five settings.
6	LCD CONTRAST	This function can be used to adjust the contrast of the Control Panel display.
7	BUZZER VOLUME	This function can be used to set the volume of alarms and the beep sounded when a key is pressed. <ul style="list-style-type: none"> The manufacturer’s default setting is “LOW”.
8	LANGUAGE	This function can be used to set the language of the display and the printed reports.
9	INITIAL MODE	This function can be used to set the mode (Copy mode or Fax mode) that the machine starts up in or returns to after the Control Panel is reset. <ul style="list-style-type: none"> The manufacturer’s default setting is “COPY”.

To select the “MACHINE SETTING” menu

- 1 Press the [Utility] key.
“MACHINE SETTING” appears.

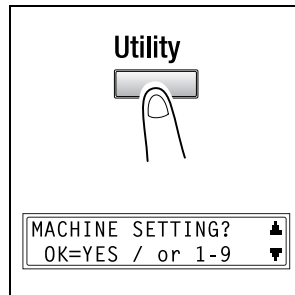

- 2 From the 10-Key Pad, press the key ([1] through [9]) for the “MACHINE SETTING” function that you wish to set.
 - The “MACHINE SETTING” functions are as follows:
 - 1 AUTO PANEL RESET
 - 2 ENERGY SAVE MODE
 - 3 AUTO SHUT OFF
 - 4 DENSITY (ADF)
 - 5 PRINT DENSITY
 - 6 LCD CONTRAST
 - 7 BUZZER VOLUME
 - 8 LANGUAGE
 - 9 INITIAL MODE

**Tip**

If, at any time, you wish to quit setting a “MACHINE SETTING” function, press the [No] key. When the message “STOP SETTING?” appears, press the [Yes] key to quit.

To set the “AUTO PANEL RESET” function

- 1** Select the “MACHINE SETTING” menu.

- Refer to “To select the “MACHINE SETTING” menu” on page 9-3.

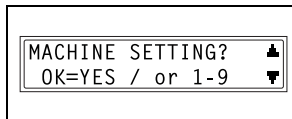

- 2** Press the [1] key from the 10-Key Pad to select “AUTO PANEL RESET”.



- 3** Using the ◀ and ▶ keys, select either “ON” or “OFF”, and then press the [Yes] key.

- If “OFF” was selected, the “MACHINE SETTING” menu appears again.

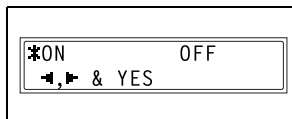

- 4** Using the ◀ and ▶ keys, select “0.5”, “1”, “2”, “3”, “4” or “5”, and then press the [Yes] key.

- The “MACHINE SETTING” menu appears again.

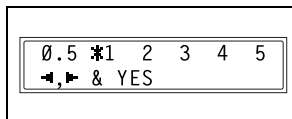

To set the “ENERGY SAVE MODE” (preheat mode) function

- 1** Select the “MACHINE SETTING” menu.

- Refer to “To select the “MACHINE SETTING” menu” on page 9-3.

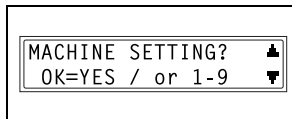

- 2** Press the [2] key from the 10-Key Pad to select “ENERGY SAVE MODE”.

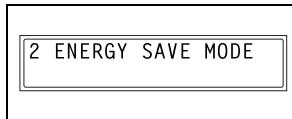

- 3** Using the 10-Key Pad, specify the length of time the machine is idle before it enters Energy Saver mode, and then press the [Yes] key.

- The timer can be set between 1 min and 240 min.
- If you wish to correct the setting, press the [No] key, and then enter the new number.

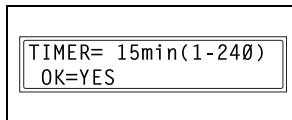

The “MACHINE SETTING” menu appears again.

To set the “AUTO SHUT OFF” function

Precautions for setting the “AUTO SHUT OFF” function:

- ✓ Whether or not auto shut off is possible depends on the “AUTO SHUT OFF” function in the “ADMIN. MANAGEMENT” menu.

1 Select the “MACHINE SETTING” menu.

- Refer to “To select the “MACHINE SETTING” menu” on page 9-3.

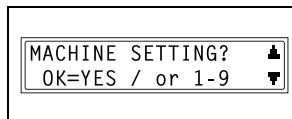

2 Press the [3] key from the 10-Key Pad to select “AUTO SHUT OFF”.

- If the “AUTO SHUT OFF” function in the “ADMIN. MANAGEMENT” menu is set to “ENABLE”, continue with step 3.
- If the “AUTO SHUT OFF” function in the “ADMIN. MANAGEMENT” menu is set to “DISABLE”, skip to step 4.

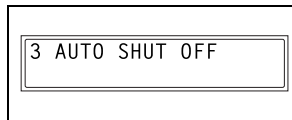

3 Using the ◀ and ▶ keys, select either “ON” or “OFF”, and then press the [Yes] key.

- If “ON” was selected, a screen appears, allowing you to specify the length of time until the machine automatically turns off. Continue with step 4.
- If “OFF” was selected, the “MACHINE SETTING” menu appears again.

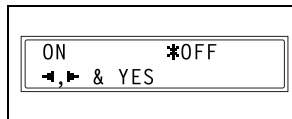

4 Using the 10-Key Pad, specify the length of time until the machine automatically turns off, and then press the [Yes] key.

- The timer can be set between 15 min and 240 min.
- If you wish to correct the setting, press the [No] key, and then enter the new number.

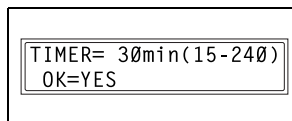

The “MACHINE SETTING” menu appears again.

**Note**

If “AUTO SHUT OFF” is set to “ON”, the auto power off function will operate. Once the power has been turned off, it will not be possible to receive faxes or perform printing from the computer.

To specify the ADF (Automatic Document Feeder) scanning image quality (“DENSITY(ADF)” function)

- 1 Select the “MACHINE SETTING” menu.
 - Refer to “To select the “MACHINE SETTING” menu” on page 9-3.

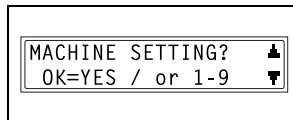

- 2 Press the [4] key from the 10-Key Pad to select “DENSITY(ADF)”.

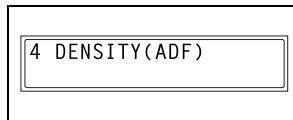

- 3 Using the ◀ and ▶ keys, select either “MODE1” or “MODE2”, and then press the [Yes] key.
The “MACHINE SETTING” menu appears again.

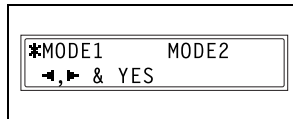

To specify the printing density (“PRINT DENSITY” function)

- 1** Select the “MACHINE SETTING” menu.

- Refer to “To select the “MACHINE SETTING” menu” on page 9-3.

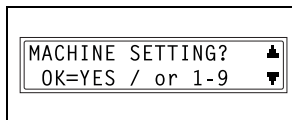

- 2** Press the [5] key from the 10-Key Pad to select “PRINT DENSITY”.

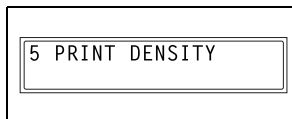

- 3** Using the ◀ and ▶ keys, select one of the five settings between “LIGHT” and “DARK”, and then press the [Yes] key.

The “MACHINE SETTING” menu appears again.

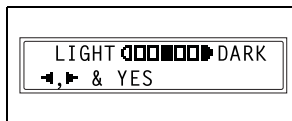

To set the “LCD CONTRAST” function

- 1** Select the “MACHINE SETTING” menu.

- Refer to “To select the “MACHINE SETTING” menu” on page 9-3.

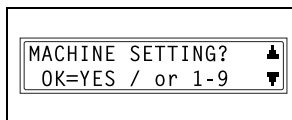

- 2** Press the [6] key from the 10-Key Pad to select “LCD CONTRAST”.

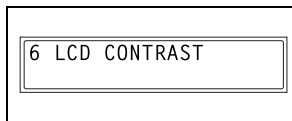

- 3** Using the ◀ and ▶ keys, select one of the four settings between “LIGHT” and “DARK”, and then press the [Yes] key.

The “MACHINE SETTING” menu appears again.

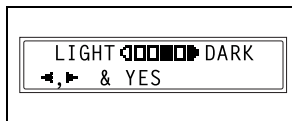

To set the “BUZZER VOLUME” function

- 1** Select the “MACHINE SETTING” menu.

- Refer to “To select the “MACHINE SETTING” menu” on page 9-3.

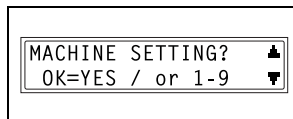

- 2** Press the [7] key from the 10-Key Pad to select “BUZZER VOLUME”.

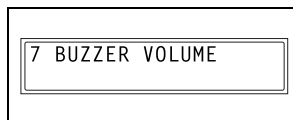

- 3** Using the ◀ and ▶ keys, select “HIGH”, “LOW” or “OFF”, and then press the [Yes] key.

The “MACHINE SETTING” menu appears again.

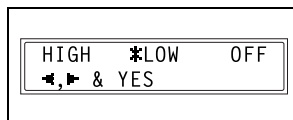
**To set the “LANGUAGE” function**

- 1** Select the “MACHINE SETTING” menu.

- Refer to “To select the “MACHINE SETTING” menu” on page 9-3.

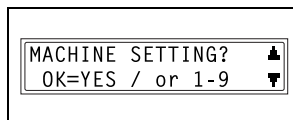

- 2** Press the [8] key from the 10-Key Pad to select “LANGUAGE”.

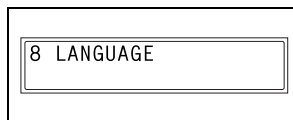

- 3** Using the ▲ and ▼ keys, select the desired language, and then press the [Yes] key.

The “MACHINE SETTING” menu appears again.

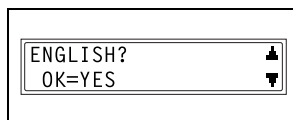

To set the “INITIAL MODE” function

- 1** Select the “MACHINE SETTING” menu.

- Refer to “To select the “MACHINE SETTING” menu” on page 9-3.

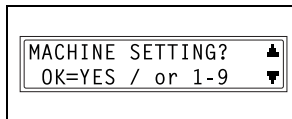

- 2** Press the [9] key from the 10-Key Pad to select “INITIAL MODE”.

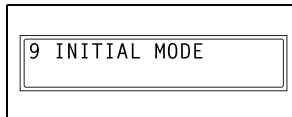

- 3** Using the ◀ and ▶ keys, select either “COPY” or “FAX”, and then press the [Yes] key.

The “MACHINE SETTING” menu appears again.

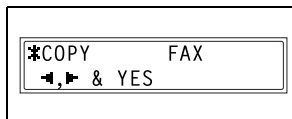

9.2 Setting Up the Paper Sources (“PAPER SOURCE SETUP” Menu)

From the “PAPER SOURCE SETUP” menu, various functions for the paper trays can be set.

“PAPER SOURCE SETUP” menu:

No.	PAPER SOURCE SETUP	Description
1	INCH/METRIC	This function can be used to set the size measurement system for the paper loaded in each tray. It can be used to select whether paper measured in centimeters such as A4 and B5 sizes (“METRIC”) or paper measured in inches (“INCH”) such as Letter size is loaded. If no particular setting is selected, the paper size is detected automatically. <ul style="list-style-type: none"> • The manufacturer’s default setting is “INCH”.
2	TRAY1 PAPER	This function can be used to set the type of paper (plain paper, OHP transparencies or postcards) loaded into the 1st Tray, and whether the size is automatically detected (AUTO) or specified (SIZE INPUT). <ul style="list-style-type: none"> • The manufacturer’s default settings are “PLAIN” and “AUTO”.
3	AUTO SELECT	Since all trays are normally available for automatic paper selection, special paper loaded into a tray may be automatically selected and wrongly copied onto. For this reason, if this function is used to set the tray to “DISABLE”, the paper in that tray will not be available for automatic paper selection. In addition, it will not be available for automatic paper source selection. <p>“ENABLE”: Paper and tray can be automatically selected.</p> <p>“DISABLE” & “CONTINUOUS”: Paper cannot be automatically selected, but tray can be automatically selected.</p> <p>“DISABLE” & “FIXED”: Paper and tray cannot be automatically selected.</p> <ul style="list-style-type: none"> • The manufacturer’s default setting is “ENABLE”.

To select the “PAPER SOURCE SETUP” menu

- 1 Press the [Utility] key.

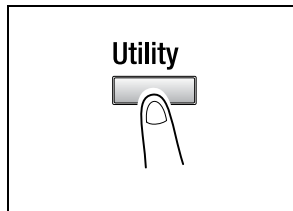

- 2 Press the ▼ key once to select “PAPER SOURCE SETUP”.

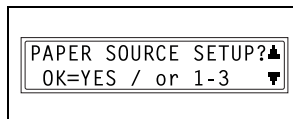

- 3 From the 10-Key Pad, press the key ([1] through [3]) for the “PAPER SOURCE SETUP” function that you wish to set.
- The “PAPER SOURCE SETUP” functions are as follows:
 - 1 INCH/METRIC
 - 2 TRAY1 PAPER
 - 3 AUTO SELECT



Tip

If, at any time, you wish to quit setting a “PAPER SOURCE SETTING” function, press the [No] key. When the message “STOP SETTING?” appears, press the [Yes] key to quit.

To specify the automatic paper size detection units (“INCH/METRIC” function)

- 1** Select the “PAPER SOURCE SETUP” menu.
- Refer to “To select the “PAPER SOURCE SETUP” menu” on page 9-12.

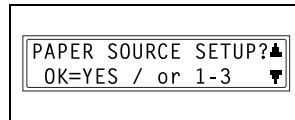

- 2** Press the [1] key from the 10-Key Pad to select “INCH/METRIC”.

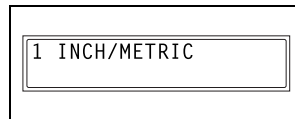

- 3** Using the ▲ and ▼ keys, select a paper tray, and then press the [Yes] key.

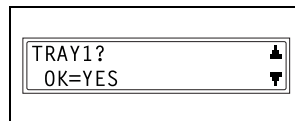

- 4** Using the ◀ and ▶ keys, select either “METRIC” or “INCH”, and then press the [Yes] key.

The “PAPER SOURCE SETUP” menu appears again.

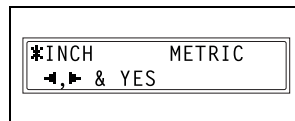

To specify the size of paper loaded into the 1st Tray (“TRAY1 PAPER” function)

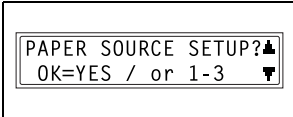
- 1 Select the “PAPER SOURCE SETUP” menu.
 - Refer to “To select the “PAPER SOURCE SETUP” menu” on page 9-12.

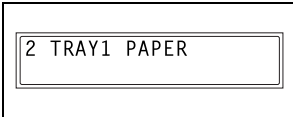
- 2 Press the [2] key from the 10-Key Pad to select “TRAY1 PAPER”.
 

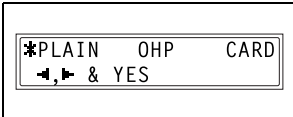
- 3 Using the ◀ and ▶ keys, select “PLAIN”, “OHP” or “CARD”, and then press the [Yes] key.
 

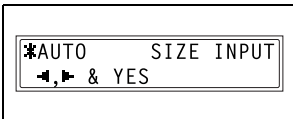
- 4 Using the ◀ and ▶ keys, select either “AUTO” or “SIZE INPUT”, and then press the [Yes] key.
 - If “AUTO” was selected, the “PAPER SOURCE SETUP” menu appears again.
 - If “SIZE INPUT” was selected, a screen appears, allowing you to specify the paper size.

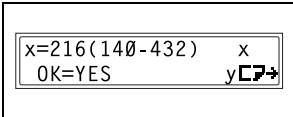
- 5 Using the 10-Key Pad, enter the paper length (mm), and then press the [Yes] key.
 - The paper length can be set between 5-1/2 inch (140 mm) and 17 inch (432 mm). However, when the length is set between 16-9/16 inch (421 mm) and 17 inch (432 mm), the maximum width that can be set is 11 inch (279 mm).
 - If you wish to correct the setting, press the [No] key, and then enter the new number.

? Have the necessary precautions been observed when entering the paper size?

- Refer to the diagram at the right and be sure to specify the paper width and length measurements correctly.

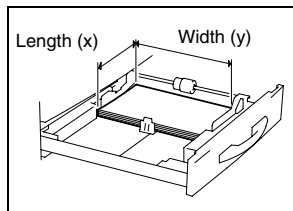

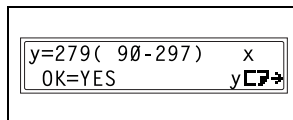

6 Using the 10-Key Pad, enter the paper width (mm), and then press the [Yes] key.

- The paper width can be set between 3-9/16 inch (90 mm) and 11-3/4 inch (297 mm). However, when the width is set between 11-1/16 inch (280 mm) and 11-11/16 inch (297 mm), the maximum length that can be set is 16-1/2 inch (420 mm).
- If you wish to correct the setting, press the [No] key, and then enter the new number.

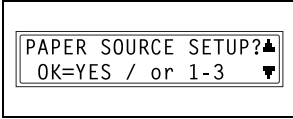
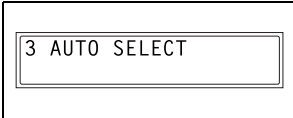

The "PAPER SOURCE SETUP" menu appears again.

To set the “AUTO SELECT” function

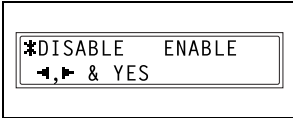
- 1 Select the “PAPER SOURCE SETUP” menu.
 - Refer to “To select the “PAPER SOURCE SETUP” menu” on page 9-12.
- 2 Press the [3] key from the 10-Key Pad to select “AUTO SELECT”.
 
- 3 Using the ▲ and ▼ keys, select a paper tray, and then press the [Yes] key.
 
- 4 Using the ◀ and ▶ keys, select either “DISABLE” (does not allow automatic paper selection) or “ENABLE” (allows automatic paper selection), and then press the [Yes] key.
 - If “DISABLE” was selected, a screen appears, allowing you to set paper source switching.
 - If “ENABLE” was selected, the “PAPER SOURCE SETUP” menu appears again.
- 5 Using the ◀ and ▶ keys, select either “FIXED” (does not allow automatic paper source switching) or “CONTINUOUS” (allows automatic paper source switching), and then press the [Yes] key.

The “PAPER SOURCE SETUP” menu appears again.

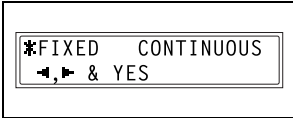

9.3 Specifying User-Managed Service Tasks (“USER MANAGEMENT” Menu)

From the “USER MANAGEMENT” menu, certain service operations can be performed in order to maintain the machine’s efficiency.

“USER MANAGEMENT” menu:

No.	USER MANAGEMENT	Description
1	DRUM DEHUMIDIFY	When the room temperature changes drastically (such as when a heater is used in the winter) or when the machine is used in an extremely humid location, condensation may form on the surface of the PC drum inside the machine, resulting in decreased print quality. If this occurs, use this function to dry the drum and eliminate the condensation.
2	TONER REPLENISHER	After many documents containing large printed areas (such as photos) or many negative/positive-inverted copies are printed, the print density may temporarily become too light if toner is not automatically replenished. If this occurs, use this function to force replenishing of the toner and immediately return the density to its normal level.

To perform the “DRUM DEHUMIDIFY” function

- 1 Press the [Utility] key.

The first screen of the Utility mode appears.

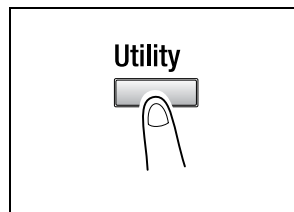

- 2 Press the ▼ key twice to select “USER MANAGEMENT”.



- 3 Using the ▲ and ▼ keys, select “DRUM DEHUMIDIFY”, and then press the [Yes] key.

Drum drying begins, and the main screen appears.

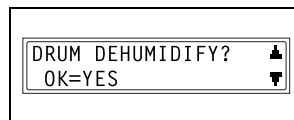

To perform the “TONER REPLENISHER” function

- 1 Press the [Utility] key.

The first screen of the Utility mode appears.

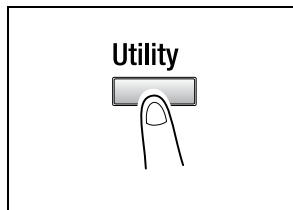

- 2 Press the ▼ key twice to select “USER MANAGEMENT”.

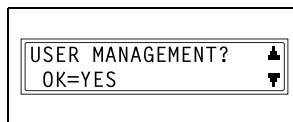

- 3 Using the ▲ and ▼ keys, select “TONER REPLENISHER”, and then press the [Yes] key.

Toner replenishing begins, and the main screen appears.

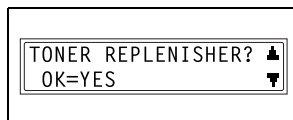

Note

While the toner is being replenished, do not turn off the machine or open the Front Cover.

If the density of the toner is suitable, do not perform the toner replenishing operation.

9.4 Specifying Administrative Settings (“ADMIN. MANAGEMENT” Menu)

From the “ADMIN. MANAGEMENT” menu, various functions for controlling the use of the machine can be set. In order to set an “ADMIN. MANAGEMENT” function, the administrator access number must be entered.

“ADMIN. MANAGEMENT” menu:

No.	ADMIN. MANAGEMENT	Description
1	AUTO SHUT OFF	This function can be used to set whether or not the auto power-off function is performed. <ul style="list-style-type: none"> • The manufacturer’s default setting is “ENABLE”.
2	COPY TRACK	A maximum of 20 accounts can be specified in order to control the use of the machine. <ul style="list-style-type: none"> • Turn on/off user management. • Register account access numbers. • Change/delete account access numbers. • Display/clear the total count for a specific account. • Print the total counts for all accounts. • Clear the total counts for all accounts.
3	REMOTE MONITOR	This function can be used to set whether or not the machine can be accessed and the status of the machine can be checked from the service center. <p>* For details, consult with the service representative.</p>



Note

The registering and setup of the administrator access number should be performed by the service representative. For details, contact the service representative.

The administrator of this machine should be sure not to lose the administrator access number.

To select the “ADMIN. MANAGEMENT” menu

- 1 Press the [Utility] key.

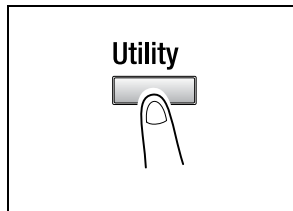

- 2 Press the ▼ key 3 times to select “ADMIN. MANAGEMENT”, and then press the [Yes] key.

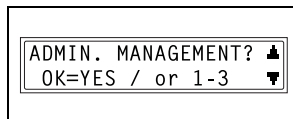

- 3 Using the 10-Key Pad, enter the 6-digit administrator access number, and then press the [Yes] key.

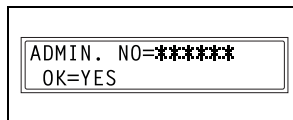

- 4 From the 10-Key Pad, press the key ([1] through [3]) for the “ADMIN. MANAGEMENT” function that you wish to set.
- The “ADMIN. MANAGEMENT” functions are as follows:
 - 1 AUTO SHUT OFF
 - 2 COPY TRACK
 - 3 REMOTE MONITOR



Tip

If, at any time, you wish to quit setting an “ADMIN. MANAGEMENT” function, press the [No] key. When the message “STOP SETTING?” appears, press the [Yes] key to quit.

To set the “AUTO SHUT OFF” function

- 1** Select the “ADMIN. MANAGEMENT” menu.
- Refer to “To select the “ADMIN. MANAGEMENT” menu” on page 9-20.

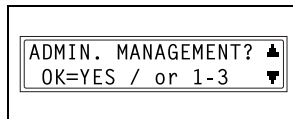

- 2** Press the [1] key from the 10-Key Pad to select “AUTO SHUT OFF”.

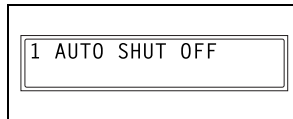

- 3** Using the ◀ and ▶ keys, select either “DISABLE” or “ENABLE”, and then press the [Yes] key.

The “ADMIN. MANAGEMENT” menu appears again.

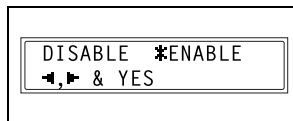
**Note**

If “AUTO SHUT OFF” is set to “DISABLE”, the auto power off function will operate. Note that once the power has been turned off, it will not be possible to receive faxes or perform printing from the computer.

To turn on/off user (section) management

- 1 Select the “ADMIN. MANAGEMENT” menu.
 - Refer to “To select the “ADMIN. MANAGEMENT” menu” on page 9-20.

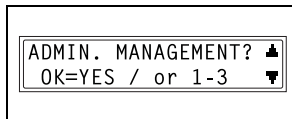

- 2 Press the [2] key from the 10-Key Pad to select “COPY TRACK”.

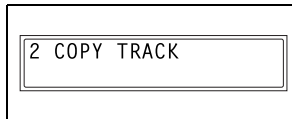

- 3 Using the ▲ and ▼ keys, select “COPY TRACK MODE”, and then press the [Yes] key.

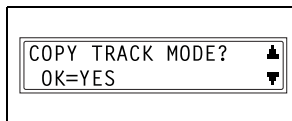

- 4 Using the ◀ and ▶ keys, select either “ON” or “OFF”, and then press the [Yes] key.

The “ADMIN. MANAGEMENT” menu appears again.

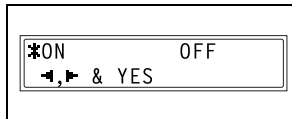

To register user (section) access numbers

- 1** Select the “ADMIN. MANAGEMENT” menu.
- Refer to “To select the “ADMIN. MANAGEMENT” menu” on page 9-20.

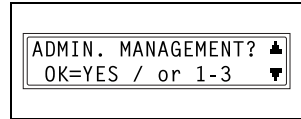

- 2** Press the [2] key from the 10-Key Pad to select “COPY TRACK”.

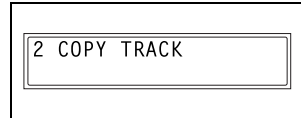

- 3** Using the ▲ and ▼ keys, select “ACCESS NO. REG.”, and then press the [Yes] key.

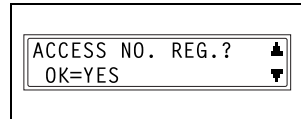

- 4** Using the 10-Key Pad, enter the desired access number for the account (section), and then press the [Yes] key.

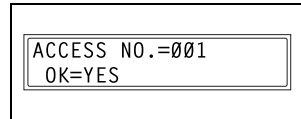

- Enter a 3-digit access number.
- If you wish to correct the access number, press the [No] key, and then use the 10-Key Pad to enter the new number.

Once the access number is registered, a screen appears, allowing you to enter the next access number to be registered.

- 5** When you are finished registering access numbers, press the [No] key.

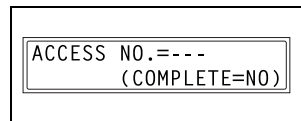

The “ADMIN. MANAGEMENT” menu appears again.

**Note**

If you try to register more than 20 access numbers, the message “UP TO 20 SECTIONS” appears.

To change/delete user (section) access numbers

- 1** Select the “ADMIN. MANAGEMENT” menu.

- Refer to “To select the “ADMIN. MANAGEMENT” menu” on page 9-20.



- 2** Press the [2] key from the 10-Key Pad to select “COPY TRACK”.



- 3** Using the ▲ and ▼ keys, select “ACCESS NO. REG.”, and then press the [Yes] key.

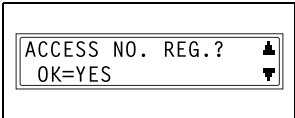

- 4** Using the 10-Key Pad, enter the access number that you wish to change/delete, and then press the [Yes] key.

- Enter a 3-digit access number.
- If you wish to correct the access number, press the [No] key, and then enter the new number.

A confirmation message appears, asking whether or not to keep the registered access number.



- 5** To change/delete the access number, press the [No] key.

- To keep the currently registered access number, press the [Yes] key.



- 6** Using the ◀ and ▶ keys, select either “EDIT” or “DELETE”, and then press the [Yes] key.

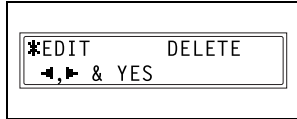

- If “EDIT” was selected, a screen appears, allowing you to edit the access number. (Continue with step 7.)
- If “DELETE” was selected, the current access number is deleted. (The message “ACCESS NO. XXX DELETED” appears.) To change or delete other access numbers, return to step 3.

- 7** Use the 10-Key Pad to enter the new number.

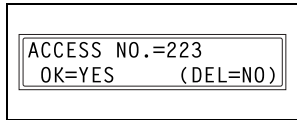

- 8** Press the [Yes] key.

- If the new access number has already been registered, the message “ACCESS NO. IS USED” appears. Press the [No] key, and then enter a different access number.

After the message “ACCESS NO. XXX EDITED” appears, a screen appears, allowing you to enter the next access number to be changed/ deleted.

- 9** When you are finished changing/ deleting access numbers, press the [No] key.

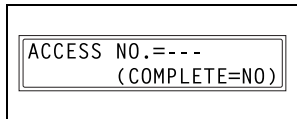

The “ADMIN. MANAGEMENT” menu appears again.

To display/clear the total count for a specific account

- 1 Select the “ADMIN. MANAGEMENT” menu.
- Refer to “To select the “ADMIN. MANAGEMENT” menu” on page 9-20.

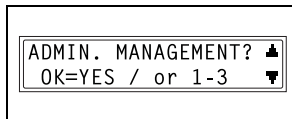

- 2 Press the [2] key from the 10-Key Pad to select “COPY TRACK”.

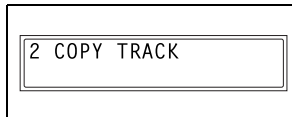

- 3 Using the ▲ and ▼ keys, select “COPY TRACK DATA”, and then press the [Yes] key.

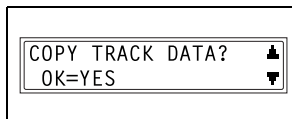

- 4 Using the ◀ and ▶ keys, select “DISPLAY”, and then press the [Yes] key.

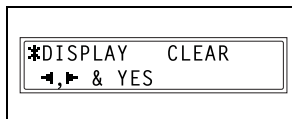

- 5 Using the ▲ and ▼ keys, select the access number for the counter that you wish to check, and then press the [Yes] key.

- The desired access (section) number can also be entered using the 10-Key Pad.
- When clearing the counter for a specific account (section), the access (section) number for that account should be selected.

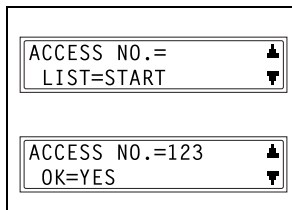

The total count for the selected account (section) is displayed.

- 6** To clear the counter, press the [No] key. (Continue with step 7.) To finish without clearing the counter, press the [Yes] key. The “COPY TRACK DATA” function appears again.



```
TOTAL PRINT=222222
FINISH=YES (CLEAR=NO)
```

- 7** After the counter is cleared, press the [Yes] key.
- After clearing the counter, if you wish to reset the counter to the previous count, press the [Interrupt] key.



```
TOTAL PRINT=000000
FINISH=YES
```

The “COPY TRACK DATA” function appears again.

To print the total counts for all accounts (sections)

- 1 Select the “ADMIN. MANAGEMENT” menu.
 - Refer to “To select the “ADMIN. MANAGEMENT” menu” on page 9-20.

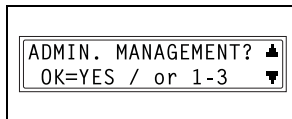

- 2 Press the [2] key from the 10-Key Pad to select “COPY TRACK”.

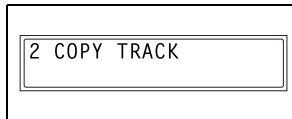

- 3 Using the ▲ and ▼ keys, select “COPY TRACK DATA”, and then press the [Yes] key.

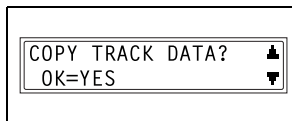

- 4 Using the ◀ and ▶ keys, select “DISPLAY”, and then press the [Yes] key.

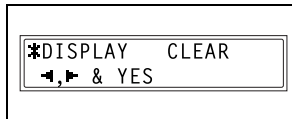

- 5 Press the [Start] key.
 The total counts for all accounts (sections) are printed on Letter-size paper.
 After 2 seconds, the “COPY TRACK DATA” function appears again.

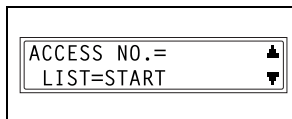

To clear the total counts for all accounts

- 1 Select the “ADMIN. MANAGEMENT” menu.
 - Refer to “To select the “ADMIN. MANAGEMENT” menu” on page 9-20.

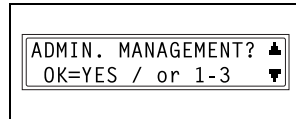

- 2 Press the [2] key from the 10-Key Pad to select “COPY TRACK”.

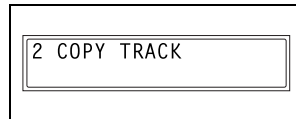

- 3 Using the ▲ and ▼ keys, select “COPY TRACK DATA”, and then press the [Yes] key.

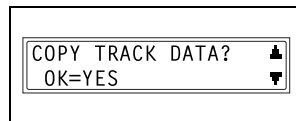

- 4 Using the ◀ and ▶ keys, select “CLEAR”, and then press the [Yes] key.

A confirmation message appears, asking whether or not to clear all counters.

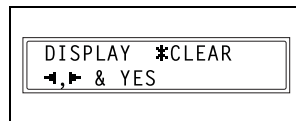

- 5 Press the [Yes] key.

After the message “SECTION COUNTER CLEARED” appears, the “COPY TRACK DATA” function appears again.

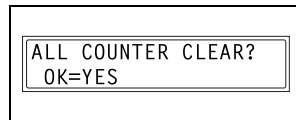

To set the “REMOTE MONITOR” function

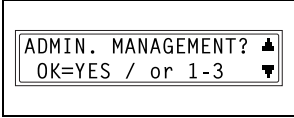
- 1 Select the “ADMIN. MANAGEMENT” menu.
 - Refer to “To select the “ADMIN. MANAGEMENT” menu” on page 9-20.

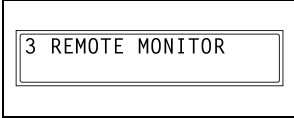
- 2 Press the [3] key from the 10-Key Pad to select “REMOTE MONITOR”.
 

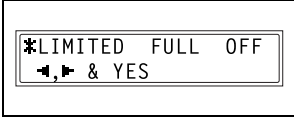
- 3 Using the ◀ and ▶ keys, select “LIMITED”, “FULL” or “OFF”, and then press the [Yes] key.
 - If “LIMITED” or “OFF” was selected, the “ADMIN. MANAGEMENT” menu appears again.
 - If “FULL” was selected, a screen appears, allowing you to enter the password.

- 4 Using the 10-Key Pad, enter the 4-digit password, and then press the [Yes] key.

The “ADMIN. MANAGEMENT” menu appears again.

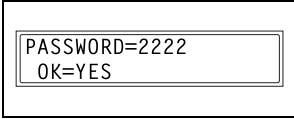

9.5 Specifying Copy Settings (“COPY SETTING 1” & “COPY SETTING 2” Menus)

The settings that are automatically selected when the machine is turned off or the [Panel Reset] key is pressed are called the “default settings”. From the “COPY SETTING 1” menu, the default settings for various functions can be specified.

“COPY SETTING 1” menu:

No.	COPY SETTING 1	Description
1	PAPER PRIORITY	This function can be used to specify the paper size or tray that should be given priority when the “Auto” zoom setting is selected. <ul style="list-style-type: none"> The manufacturer’s default setting is “Letter C”.
2	DENSITY PRIORITY	This function can be used to set the density to “AUTO”, “MANUAL” or “PHOTO” when the machine is turned off or the [Panel Reset] key is pressed. <ul style="list-style-type: none"> The manufacturer’s default setting is “AUTO”.
3	DENSITY LEVEL(A)	This function can be used to set the density level of the “AUTO” density setting to one of the three settings between “LIGHT” and “DARK”. <ul style="list-style-type: none"> The manufacturer’s default setting is the middle level.
4	DENSITY LEVEL(M)	This function can be used to set the density level of the manual density setting to one of the five settings between “LIGHT” and “DARK”. <ul style="list-style-type: none"> The manufacturer’s default setting is the middle level.
5	BINDING POS.	This function can be used to set whether the first page of a book to be scanned is on the left (left-bound) or on the right (right-bound). <ul style="list-style-type: none"> The manufacturer’s default setting is “LEFT”.
6	MARGIN SETTING	This function can be used to specify between 0 inch and 3/4 inch (20 mm), (in units of Approx. 1/16 inch (1 mm)) the width of the binding area (margin) when copying documents to be bound. <ul style="list-style-type: none"> The manufacturer’s default setting is 1/2 inch (10 mm).
7	ERASE SETTING	This function can be used to specify between 1/4 inch (5 mm) and 3/4 inch (20 mm), (in units of Approx. 1/16 inch (1 mm)) the width that is erased when making copies with the “Erase” function set to “Left”, “Upper” and “Frame”. <ul style="list-style-type: none"> The manufacturer’s default setting for the “Left”, “Upper” and “Frame” erase settings is 1/2 inch (10 mm).

“COPY SETTING 2” menu:

No.	COPY SETTING 2	Description								
1	MIXED ORIGINAL	This function can be used to set whether or not the “Mixed Orig.” function is selected when the machine starts up or after the Control Panel is reset. <ul style="list-style-type: none"> The manufacturer’s default setting is “OFF”. 								
2	COPY PRIORITY	This function can be used to set whether the automatic paper or automatic zoom ratio setting is selected when the machine starts up or after the Control Panel is reset. <ul style="list-style-type: none"> The manufacturer’s default setting is “AP”(auto paper selection). 								
3	OUTPUT PRIORITY	This function can be used to specify if the selected finishing mode is “NON”, “SORT” or “GROUP” when the machine is turned off or the [Panel Reset] key is pressed. <ul style="list-style-type: none"> The manufacturer’s default setting is “NON”. 								
4	4IN1 COPY ORDER	This function can be used to select from the following for the page order when the 4in1 copy mode is selected. “PATTERN1” “PATTERN2” <div style="display: flex; justify-content: space-around; align-items: center; margin: 10px 0;"> <table border="1" style="border-collapse: collapse; text-align: center;"> <tr><td>1</td><td>2</td></tr> <tr><td>3</td><td>4</td></tr> </table> <table border="1" style="border-collapse: collapse; text-align: center;"> <tr><td>1</td><td>3</td></tr> <tr><td>2</td><td>4</td></tr> </table> </div> <ul style="list-style-type: none"> The manufacturer’s default setting is “PATTERN1”. 	1	2	3	4	1	3	2	4
1	2									
3	4									
1	3									
2	4									
5	CRISSCROSS MODE	This function can be used to set whether or not copies are fed out in a crisscross pattern when the crisscross output conditions are met. <ul style="list-style-type: none"> The manufacturer’s default setting is “ON”. 								

To select the “COPY SETTING 1” menu

- 1 Press the [Utility] key.

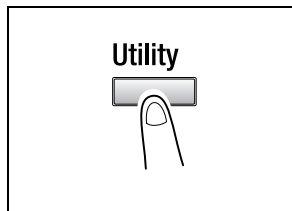

- 2 Press the ▼ key 4 times to select “COPY SETTING 1”.

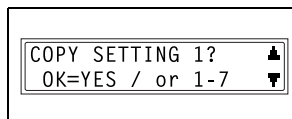

- 3** From the 10-Key Pad, press the key ([1] through [7]) for the “COPY SETTING 1” function that you wish to set.
- The “COPY SETTING 1” functions are as follows:
 - 1 PAPER PRIORITY
 - 2 DENSITY PRIORITY
 - 3 DENSITY LEVEL(A)
 - 4 DENSITY LEVEL(M)
 - 5 BINDING POS.
 - 6 MARGIN SETTING
 - 7 ERASE SETTING



Tip

If, at any time, you wish to quit setting a “COPY SETTING 1” function, press the [No] key. When the message “STOP SETTING?” appears, press the [Yes] key to quit.

To set the “PAPER PRIORITY” function

- 1** Select the “COPY SETTING 1” menu.

- Refer to “To select the “COPY SETTING 1” menu” on page 9-32.

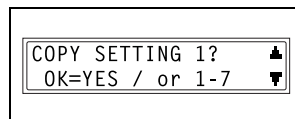

- 2** Press the [1] key from the 10-Key Pad to select “PAPER PRIORITY”.

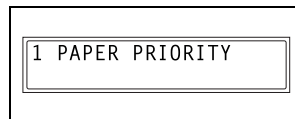

- 3** Using the ◀ and ▶ keys, select a paper size or paper tray, and then press the [Yes] key.

- Select from the following paper sizes and paper trays.

A5 C, A5 L, A4 C, A4 L, A3 L, B5 C, B5 L, B4 L, Half Letter C (Invoice C), Half Letter L (Invoice L), Letter C, Letter L, Legal L, 11 × 14, 11 × 17, FLS, 1st Tray, 2nd Tray, 3rd Tray*, 4th Tray*, 5th Tray*, Multiple Bypass Tray

*Only with Di183/Di183f

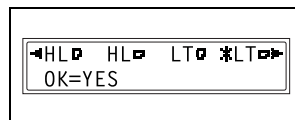

The “COPY SETTING 1” menu appears again.

To set the “DENSITY PRIORITY” function

- 1 Select the “COPY SETTING 1” menu.
 - Refer to “To select the “COPY SETTING 1” menu” on page 9-32.
- 2 Press the [2] key from the 10-Key Pad to select “DENSITY PRIORITY”.

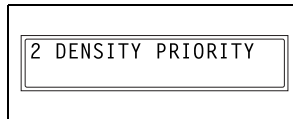
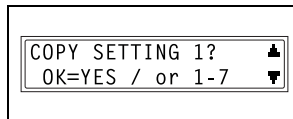

- 3 Using the ◀ and ▶ keys, select “AUTO”, “MANUAL” or “PHOTO”, and then press the [Yes] key.

The “COPY SETTING 1” menu appears again.

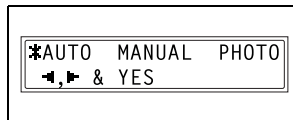

To set the “AUTO” density level (“DENSITY LEVEL(A)” function)

- 1 Select the “COPY SETTING 1” menu.
 - Refer to “To select the “COPY SETTING 1” menu” on page 9-32.
- 2 Press the [3] key from the 10-Key Pad to select “DENSITY LEVEL(A)”.
- 3 Using the ◀ and ▶ keys, select one of the three settings between “LIGHT” and “DARK”, and then press the [Yes] key.

The “COPY SETTING 1” menu appears again.

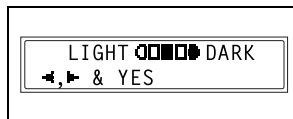
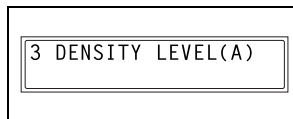
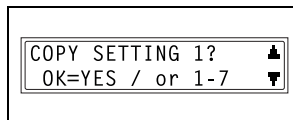

To set the manual density level (“DENSITY LEVEL(M)” function)

- 1 Select the “COPY SETTING 1” menu.
 - Refer to “To select the “COPY SETTING 1” menu” on page 9-32.
- 2 Press the [4] key from the 10-Key Pad to select “DENSITY LEVEL(M)”.

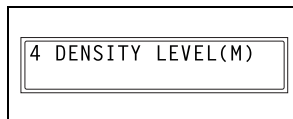
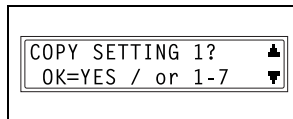

- 3 Using the ◀ and ▶ keys, select one of the five settings between “LIGHT” and “DARK”, and then press the [Yes] key.

The “COPY SETTING 1” menu appears again.

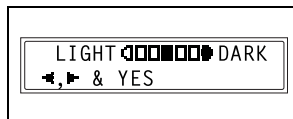
**To set the “BINDING POS.” function**

- 1 Select the “COPY SETTING 1” menu.
 - Refer to “To select the “COPY SETTING 1” menu” on page 9-32.
- 2 Press the [5] key from the 10-Key Pad to select “BINDING POS.”.
- 3 Using the ◀ and ▶ keys, select either “LEFT” or “RIGHT”, and then press the [Yes] key.

The “COPY SETTING 1” menu appears again.

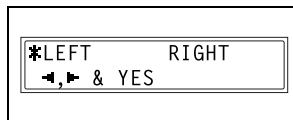
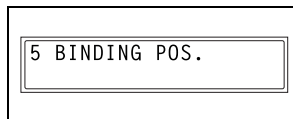
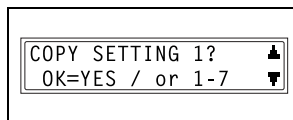

To specify the binding width (“MARGIN SETTING” function)

- 1 Select the “COPY SETTING 1” menu.
 - Refer to “To select the “COPY SETTING 1” menu” on page 9-32.

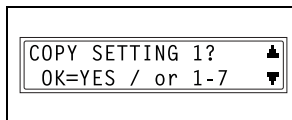

- 2 Press the [6] key from the 10-Key Pad to select “MARGIN SETTING”.



- 3 Using the 10-Key Pad, enter the binding width (margin), and then press the [Yes] key.

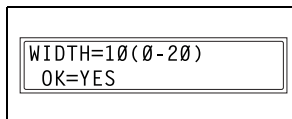

- The binding width can be set between 0 inch (0 mm) and 3/4 (20 mm).
- If you wish to correct the setting, press the [No] key, and then enter the new number.

The “COPY SETTING 1” menu appears again.

To specify the erased width (“ERASE SETTING” function)

- 1 Select the “COPY SETTING 1” menu.
 - Refer to “To select the “COPY SETTING 1” menu” on page 9-32.

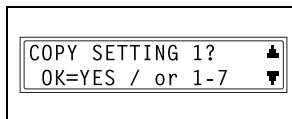

- 2 Press the [7] key from the 10-Key Pad to select “ERASE SETTING”.



- 3 Using the ◀ and ▶ keys, select “LEFT”, “UPPER” or “FRAME”, and then press the [Yes] key.

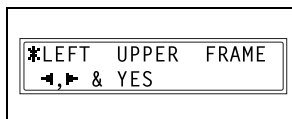

- 4 Using the 10-Key Pad, enter the width of the area to be erased, and then press the [Yes] key.

- The width of the area to be erased can be set between 1/4 inch (5 mm) and 3/4 inch (20 mm).
- If you wish to correct the setting, press the [No] key, and then enter the new number.

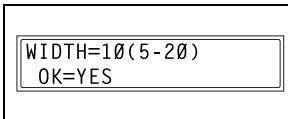

The "COPY SETTING 1" menu appears again.

To select the "COPY SETTING 2" menu

- 1 Press the [Utility] key.

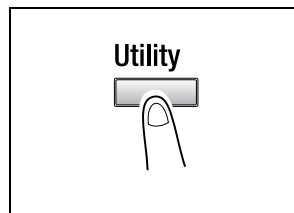

- 2 Press the ▼ key 5 times to select "COPY SETTING 2".

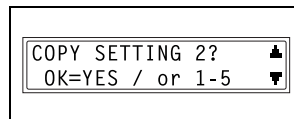

- 3 From the 10-Key Pad, press the key ([1] through [5]) for the "COPY SETTING 2" function that you wish to set.

- The "COPY SETTING 2" functions are as follows:
 - 1 MIXED ORIGINAL
 - 2 COPY PRIORITY
 - 3 OUTPUT PRIORITY
 - 4 4IN1 COPY ORDER
 - 5 CRISSCROSS MODE



Tip

If, at any time, you wish to quit setting a "COPY SETTING 2" function, press the [No] key. When the message "STOP SETTING?" appears, press the [Yes] key to quit.

To set the “MIXED ORIGINAL” function

- 1 Select the “COPY SETTING 2” menu.
 - Refer to “To select the “COPY SETTING 2” menu” on page 9-37.

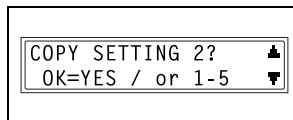

- 2 Press the [1] key from the 10-Key Pad to select “MIXED ORIGINAL”.



- 3 Using the ◀ and ▶ keys, select either “ON” or “OFF”, and then press the [Yes] key.

The “COPY SETTING 2” menu appears again.

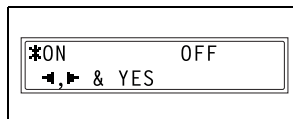
**To set the “COPY PRIORITY” function**

- 1 Select the “COPY SETTING 2” menu.
 - Refer to “To select the “COPY SETTING 2” menu” on page 9-37.

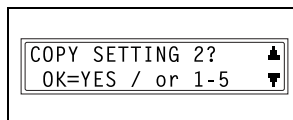

- 2 Press the [2] key from the 10-Key Pad to select “COPY PRIORITY”.

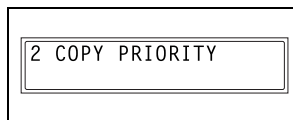

- 3 Using the ◀ and ▶ keys, select “AP” (auto paper selection), “AS” (auto zoom ratio) or “MANUAL”, and then press the [Yes] key.

The “COPY SETTING 2” menu appears again.

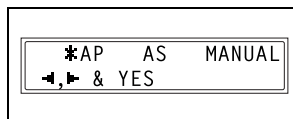

To specify the default finishing mode (“OUTPUT PRIORITY” function)

- 1 Select the “COPY SETTING 2” menu.
 - Refer to “To select the “COPY SETTING 2” menu” on page 9-37.

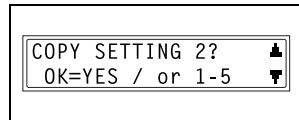

- 2 Press the [3] key from the 10-Key Pad to select “OUTPUT PRIORITY”.

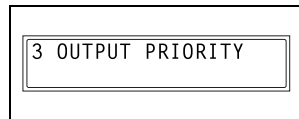

- 3 Using the ◀ and ▶ keys, select “NON”, “*SORT” or “GROUP”, and then press the [Yes] key.

The “COPY SETTING 2” menu appears again.

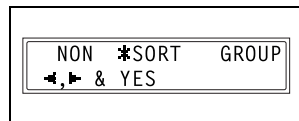

To set the “4IN1 COPY ORDER” function

- 1 Select the “COPY SETTING 2” menu.
 - Refer to “To select the “COPY SETTING 2” menu” on page 9-37.

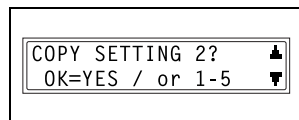

- 2 Press the [4] key from the 10-Key Pad to select “4IN1 COPY ORDER”.

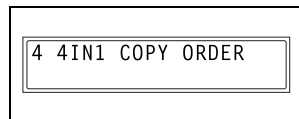

- 3 Using the ◀ and ▶ keys, select either “*PATTERN1” or “PATTERN2”, and then press the [Yes] key.

The “COPY SETTING 2” menu appears again.

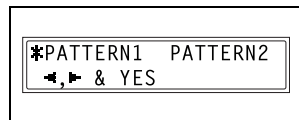

To set the “CRISSCROSS MODE” function

- 1** Select the “COPY SETTING 2” menu.

- Refer to “To select the “COPY SETTING 2” menu” on page 9-37.

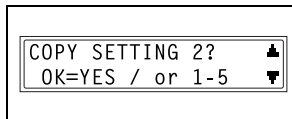

- 2** Press the [5] key from the 10-Key Pad to select “CRISSCROSS MODE”.

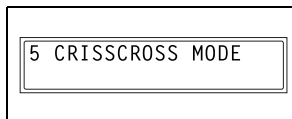

- 3** Using the ◀ and ▶ keys, select either “ON” or “OFF”, and then press the [Yes] key.

The “COPY SETTING 2” menu appears again.

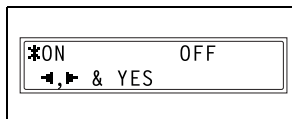

10 Utility Mode – Fax Functions

This chapter describes the various Utility mode functions that can be used to set fax-related functions.

10.1 Programming Fax Settings (“FAX REGISTRATION” Menu)

From the “FAX REGISTRATION” menu, various settings can be specified in order to take advantage of this machine’s many fax functions.

“FAX REGISTRATION” menu:

No.	FAX REGISTRATION	Characteristic/Description
1	ONE-TOUCH DIAL	This function can be used to program one-touch dial keys with fax numbers, allowing the recipient to be specified easily and accurately without the need to manually enter the number using the 10-Key Pad. A maximum of 27 fax numbers can be programmed. This dialing method is convenient for programming numbers where faxes are frequently sent to.
2	SPEED DIAL	This function can be used to program speed dial numbers with fax numbers, allowing the recipient to be specified easily and accurately without the need to manually enter the number using the 10-Key Pad. A maximum of 100 fax numbers can be programmed.
3	GROUP DIAL	This function can be used to program a single one-touch dial key with a maximum of 50 different fax numbers as one group. Programming a one-touch dial key with a group of fax numbers is convenient when documents are frequently sent to a set group of multiple recipients.
4	PROGRAM DIAL	This function can be used to program one-touch dial keys with fax numbers and a transmission/reception function (such as timer transmission or polling reception), allowing that function to be carried out by pressing just the corresponding one-touch dial key.
5	BATCH TX	This function can be used to specify the batch transmission setting (transmission time) for a one-touch dial key programmed with recipient fax numbers, so multiple documents can be stored in the memory and sent out together at the specified time.
6	MAILBOX	This function can be used to specify mailbox IDs in order to receive faxes with mailbox reception only if the mailbox ID sent by the caller matches the mailbox ID set on this machine.

No.	FAX REGISTRATION	Characteristic/Description
7	RELAY BOX	This function can be used to program the relay boxes in order for this machine (acting as a relay station) to receive a document from another fax machine (transmitting station), then transmit the document to multiple recipients (receiving stations).

To select the “FAX REGISTRATION” menu

- 1 Press the [Utility] key.

The first screen of the Utility mode appears.

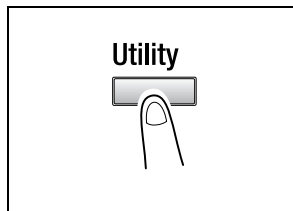

- 2 Press the ▼ key 6 times to select “FAX REGISTRATION”.

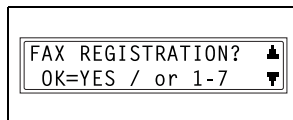

- 3 From the 10-Key Pad, press the key ([1] through [7]) for the “FAX REGISTRATION” function that you wish to set.
- The “FAX REGISTRATION” functions are as follows:
 - 1 ONE-TOUCH DIAL
 - 2 SPEED DIAL
 - 3 GROUP DIAL
 - 4 PROGRAM DIAL
 - 5 BATCH TX
 - 6 MAILBOX
 - 7 RELAY BOX



Tip

If, at any time, you wish to quit programming, changing or deleting a “FAX REGISTRATION” function, press the [No] key. When the message “STOP REGISTRATION?” appears, press the [Yes] key to quit.

Setting Up One-Touch Dialing (“ONE-TOUCH DIAL” function)

If the one-touch dial keys are programmed with fax numbers, the recipient can be specified easily and accurately without the need to manually enter the number using the 10-Key Pad.

A maximum of 27 numbers can be programmed.

A list of the information programmed in the one-touch dial keys can be printed out. Refer to “Specifying Report Output (“REPORTING” Menu)” on page 10-50.

To program a one-touch dial key

- 1** Select the “FAX REGISTRATION” menu.

- Refer to “To select the “FAX REGISTRATION” menu” on page 10-2.

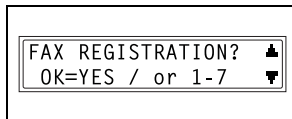

- 2** Press the [1] key from the 10-Key Pad to select “ONE-TOUCH DIAL”.

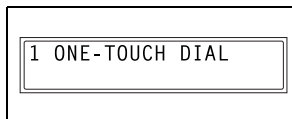

- 3** Press the one-touch dial key that you wish to program.



- 4** Using the 10-Key Pad, enter the fax number of the recipient.

- The fax number can contain a maximum of 30 digits.

For details on the characters that can be entered, refer to p. 6-8.

- To enter a sub-address, continue with step 5.
- If a sub-address will not be entered, press the [Yes] key after entering the fax number, and then skip to step 7.
- If “+” (one-touch dial key [22]) is added after the entered number, the programmed number can be used with combination dialing (p. 6-16).
- If you wish to change the fax number, press the [No] key, and then enter the correct number.
- For details on F codes (sub-address and SID), refer to “Using F codes” on page 7-25.

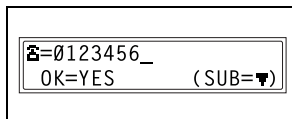

- 5** Press the ▼ key, and then use the 10-Key Pad to enter the sub-address.

- A number up to 20 digits long can be entered for the sub-address.
- To enter an SID, continue with step 6.
- If an SID will not be entered, skip to step 7.

SUB=1234_
OK=YES (SID=▼)

- 6** Press the ▼ key, and then use the 10-Key Pad to enter the SID.

- A number up to 20 digits long can be entered for the SID.

SID=5678_
OK=YES

- 7** Press the [Yes] key.

- 8** Enter the name of the programmed number.

- For details on entering text, refer to “Entering Text” on page 3-36.
- Text up to 20 characters long can be entered for the name.

NAME=AAA TOKYO_
OK=YES

- 9** Press the [Yes] key.

- 10** Using the ◀ and ▶ keys, select the desired modem speed.

- 11** Press the [Yes] key.

The settings are registered. To program another one-touch dial key, repeat steps 3 through 11.

SET MODEM SPEED

*33.6 14.4 9.6
◀, ▶ & YES

- 12** Press the [No] key to finish programming.

The “FAX REGISTRATION” menu appears again.

-SELECT REGIST.KEY-
(COMPLETE=NO)

To change/delete a programmed one-touch dial key

- 1** Select the “FAX REGISTRATION” menu.

- Refer to “To select the “FAX REGISTRATION” menu” on page 10-2.

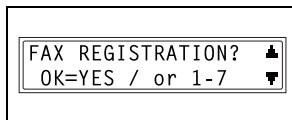

- 2** Press the [1] key from the 10-Key Pad to select “ONE-TOUCH DIAL”.

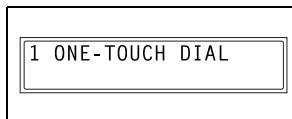

- 3** Press the one-touch dial key that you wish to change or delete.



- 4** Press the [No] key.

- If a one-touch dial key programmed with a group of fax numbers or a transmission/reception function is pressed, the message shown at the right appears. To delete the programmed settings, press the [No] key. The “FAX REGISTRATION” menu appears again.
- To change the group dialing or program dialing settings, refer to page 10-13 and page 10-16.

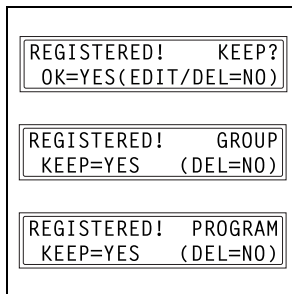

- 5 Using the ◀ and ▶ keys, select either “EDIT” or “DELETE”, and then press the [Yes] key.

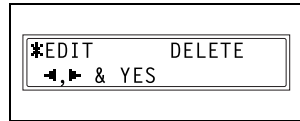

- If “EDIT” was selected, the fax number is displayed. (Continue with step 6.)
- If “DELETE” was selected, the settings programmed for the one-touch dial key are deleted and the “FAX REGISTRATION” menu appears again.
- If you try to change the settings for a one-touch dial number used in group dialing or program dialing, a confirmation message appears, asking whether or not to change the corresponding settings programmed in group dialing or program dialing. If the [Yes] key is pressed, the corresponding settings programmed in group dialing or program dialing are changed. If the [No] key is pressed, the corresponding settings programmed in group dialing or program dialing are deleted.
- If a one-touch dial number used in group dialing or program dialing is deleted, it is also deleted from the corresponding group dialing or program dialing.

- 6 Change the fax number, F codes (sub-address and SID) and modem speed as desired.

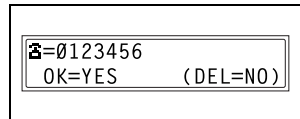

- For details on changing the fax number, refer to “Entering Text” on page 3-36.
- For details on changing the F codes (sub-address and SID) or modem speed, refer to p. 10-4.

- 7 When you are finished making changes, press the [Yes] key.

To change the settings of another one-touch dial key, repeat steps 3 through 7.

- 8 Press the [No] key to return to the “FAX REGISTRATION” menu.



Setting Up Speed Dialing (“SPEED DIAL” function)

If speed dial numbers are programmed with fax numbers, the recipient can be specified easily and accurately without the need to manually enter the number using the 10-Key Pad.

A maximum of 100 fax numbers (001 to 100) can be programmed.

A list of the information programmed in the speed dial numbers can be printed out. Refer to “Outputting a report/list (“PRINT REPORT” menu)” on page 11-3.

To program a speed dial number

- 1 Select the “FAX REGISTRATION” menu.

- Refer to “To select the “FAX REGISTRATION” menu” on page 10-2.

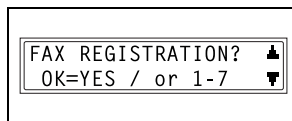

- 2 Press the [2] key from the 10-Key Pad to select “SPEED DIAL”.

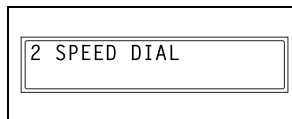

- 3 Using the 10-Key Pad, enter the 3-digit speed dial number (ex. 011) that you wish to program.

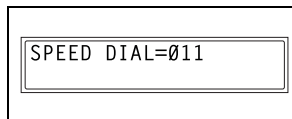

- 4** Using the 10-Key Pad, enter the fax number of the recipient.

- The fax number can contain a maximum of 30 digits.
For details on the characters that can be entered, refer to p. 6-8.
- To enter a sub-address, continue with step 5.
- If a sub-address will not be entered, press the [Yes] key after entering the fax number, and then skip to step 7.
- If “+” (one-touch dial key [22]) is added after the entered number, the programmed number can be used with combination dialing (p. 6-16).
- If you wish to change the fax number, press the [No] key, and then enter the correct number.
- For details on F codes (sub-address and SID), refer to “Using F codes” on page 7-25.

☎=0124578_
OK=YES (SUB=▼)

- 5** Press the ▼ key, and then use the 10-Key Pad to enter the sub-address.

- A number up to 20 digits long can be entered for the sub-address.
- To enter an SID, continue with step 6.
- If an SID will not be entered, skip to step 7.

SUB=1234_
OK=YES (SID=▼)

- 6** Press the ▼ key, and then use the 10-Key Pad to enter the SID.

- A number up to 20 digits long can be entered for the SID.

SID=5678_
OK=YES

- 7** Press the [Yes] key.

- 8** Enter the name of the programmed number.

- For details on entering text, refer to “Entering Text” on page 3-36.
- Text up to 20 characters long can be entered for the name.

NAME=AAA OSAKA_
OK=YES

- 9** Press the [Yes] key.

- 10** Using the ◀ and ▶ keys, select the desired modem speed.

SET MODEM SPEED

*33.6 14.4 9.6

◀,▶ & YES

- 11** Press the [Yes] key.

The settings are registered.

To program another speed dial number, repeat steps 3 through 11.

- 12** Press the [No] key to finish programming.

The “FAX REGISTRATION” menu appears again.

SPEED DIAL=_

(COMPLETE=NO)

To change/delete a programmed speed dial number

- 1** Select the “FAX REGISTRATION” menu.

- Refer to “To select the “FAX REGISTRATION” menu” on page 10-2.

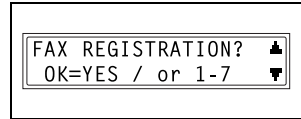

- 2** Press the [2] key from the 10-Key Pad to select “SPEED DIAL”.



- 3** Using the 10-Key Pad, enter the speed dial number that you wish to change or delete.

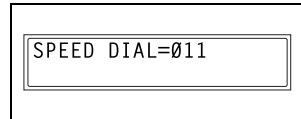

- 4** Press the [No] key.



- 5** Using the ◀ and ▶ keys, select either “EDIT” or “DELETE”, and then press the [Yes] key.

- If “EDIT” was selected, the fax number is displayed. (Continue with step 6.)
- If “DELETE” was selected, the settings programmed for the speed dial number are deleted and the “FAX REGISTRATION” menu appears again.
- If you try to change the settings for a speed dial number used in group dialing or program dialing, a confirmation message appears, asking whether or not to change the corresponding settings programmed in group dialing or program dialing. If the [Yes] key is pressed, the corresponding settings programmed in group dialing or program dialing are changed. If the [No] key is pressed, the corresponding settings programmed in group dialing or program dialing are deleted.

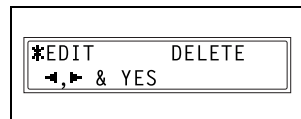

- If a speed dial number used in group dialing or program dialing is deleted, it is also deleted from the corresponding group dialing or program dialing.

- 6** Change the fax number, F codes (sub-address and SID), and modem speed as desired.

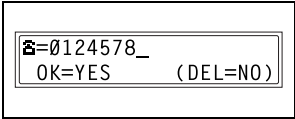

F=0124578_
OK=YES (DEL=NO)

- For details on making changes, refer to “Entering Text” on page 3-36.
- For details on changing the F codes (sub-address and SID) or modem speed, refer to p. 10-4.

- 7** When you are finished making changes, press the [Yes] key.

- To change the settings of another speed dial number, repeat steps 3 through 7.

- 8** Press the [No] key to return to the “FAX REGISTRATION” menu.



SPEED DIAL=_
(COMPLETE=NO)

Setting Up Group Dialing (“GROUP DIAL” function)

A single one-touch dial key can be programmed with a maximum of 50 different fax numbers as one group. Programming a one-touch dial key with a group of fax numbers is convenient when documents are frequently sent to a set group of multiple recipients.

A list of the information programmed for group dialing can be printed out. Refer to “Outputting a report/list (“PRINT REPORT” menu)” on page 11-3.

To program a group of fax numbers

- 1 Select the “FAX REGISTRATION” menu.

- Refer to “To select the “FAX REGISTRATION” menu” on page 10-2.

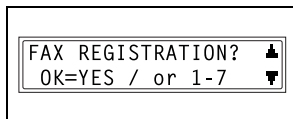

- 2 Press the [3] key from the 10-Key Pad to select “GROUP DIAL”.

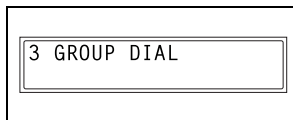

- 3 Press the one-touch dial key that you wish to program.



- 4 Enter the name of the group, and then press the [Yes] key.

- For details on entering text, refer to “Entering Text” on page 3-36.
- Text up to 20 characters long can be entered for the name.

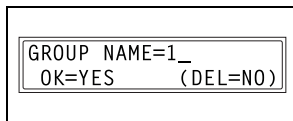

- 5 By using the one-touch dial keys or the speed dial numbers, or by entering the fax number using the 10-Key Pad, specify the recipients.

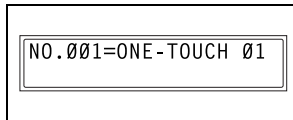

- ? *Do you wish to cancel the current selection?*

- Press the [No] key, and then specify the correct recipient.

- 6** Press the [Yes] key, and then specify another recipient.
- Repeat steps 5 and 6 until all recipients have been specified.
 - A maximum of 50 different fax numbers can be specified as one group.
 - With group dialing, a one-touch dial key programmed with a group can be specified. In that case, the number of fax numbers programmed in the specified one-touch dial key (group dial key) is added.



NO. 001=GROUP 1
OK=YES (Fin.=START)

- 7** When you are finished specifying recipients, press the [Start] key. The settings are registered. To program another group, repeat steps 3 through 8.

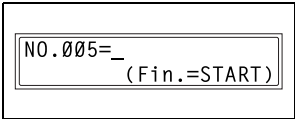

NO. 005=_ _
(Fin.=START)

- 8** Press the [No] key to finish programming. The “FAX REGISTRATION” menu appears again.





-SELECT REGIST.KEY-
(COMPLETE=NO)

To change/delete a programmed group of fax numbers

- 1** Select the “FAX REGISTRATION” menu.

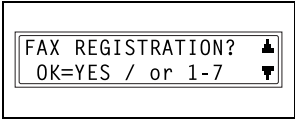
- Refer to “To select the “FAX REGISTRATION” menu” on page 10-2.



FAX REGISTRATION? 
OK=YES / or 1-7 

- 2** Press the [3] key from the 10-Key Pad to select “GROUP DIAL”.



3 GROUP DIAL

- 3** Press the one-touch dial key that you wish to change or delete.



-SELECT REGIST.KEY-

- 4 Press the [No] key.

```
REGISTERED!   KEEP?
OK=YES(EDIT/DEL=NO)
```

- 5 Using the ◀ and ▶ keys, select either “EDIT” or “DELETE”, and then press the [Yes] key.

```
*EDIT        DELETE
◀,▶ & YES
```

- If “EDIT” was selected, the group name is displayed. (Continue with step 6.)
- If “DELETE” was selected, the group dialing settings are deleted and the “FAX REGISTRATION” menu appears again.

- 6 If you wish to change the name of the group, enter the new name, and then press the [Yes] key.

```
GROUP NAME=AAA TOKYO
OK=YES      (DEL=NO)
```

- For details on making changes, refer to “Entering Text” on page 3-36.

The fax numbers are displayed in the order that they were specified.

- 7 To delete the displayed fax number, press the [No] key.
To keep the displayed fax number, press the [Yes] key.

```
NO.001=AAA TOKYO
OK=YES      (DEL=NO)
```

The next fax number is displayed.

- 8 When you are finished making changes, press the [Start] key.

To change the settings of another group of fax numbers, repeat steps 3 through 8.

```
NO.005=_
(Fin.=START)
```

- 9 Press the [No] key to return to the “FAX REGISTRATION” menu.

```
-SELECT REGIST.KEY-
(COMPLETE=NO)
```

Setting Up Program Dialing (“PROGRAM DIAL” function)

If one-touch dial keys have been programmed with fax numbers and a transmission/reception function, that function can be carried out by pressing just the corresponding one-touch dial key.

Transmission/reception functions that can be programmed:

- Broadcast transmission
- Timer transmission
- Mailbox transmission
- Polling reception
- Relay initiation transmission

To set program dialing

- 1 Select the “FAX REGISTRATION” menu.

- Refer to “To select the “FAX REGISTRATION” menu” on page 10-2.

A rectangular screen with a double-line border. Inside, the text reads "FAX REGISTRATION?" followed by a small upward-pointing arrow icon. Below that, it says "OK=YES / or 1-7" followed by a small downward-pointing arrow icon.

FAX REGISTRATION? ▲
OK=YES / or 1-7 ▼

- 2 Press the [4] key from the 10-Key Pad to select “PROGRAM DIAL”.

A rectangular screen with a double-line border. Inside, the text reads "4 PROGRAM DIAL".

4 PROGRAM DIAL

- 3 Press the one-touch dial key ([24] through [27]) programmed with the desired function.

A rectangular screen with a double-line border. Inside, the text reads "-SELECT REGIST.KEY-".

-SELECT REGIST.KEY-

- 4** From the 10-Key Pad, press the key ([1] through [3], [6] or [7]) for the desired function.

- Functions that can be selected:
 - 1 BROADCAST
 - 2 TIMER TX
 - 3 MAILBOX TX
 - 6 POLLING RX
 - 7 RELAY INITIATE

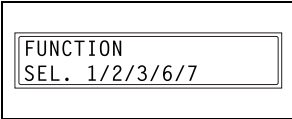

FUNCTION
SEL. 1/2/3/6/7

- 5** Follow the instructions for the selected function.

- “To fax using broadcast transmission” on page 7-4
- “To fax using timer transmission” on page 7-7
- “To fax using mailbox transmission” on page 7-9
- “To fax using relay initiation transmission” on page 7-11
- “To receive a fax using polling reception” on page 7-23

The settings are registered.

- 6** To specify other program dialing settings, repeat steps 3 through 5.

- 7** Press the [No] key to finish programming.

The “FAX REGISTRATION” menu appears again.



-SELECT REGIST.KEY-
(COMPLETE=NO)

To change/delete a programmed broadcast transmission

- 1** Select the “FAX REGISTRATION” menu.

- Refer to “To select the “FAX REGISTRATION” menu” on page 10-2.



FAX REGISTRATION? ▲
OK=YES / or 1-7 ▼

- 2** Press the [4] key from the 10-Key Pad to select “PROGRAM DIAL”.



4 PROGRAM DIAL

- 3** Press the one-touch dial key ([24] through [27]) programmed with the broadcast transmission that you wish to change or delete.

-SELECT REGIST.KEY-

- 4** Press the [No] key.

REGISTERED! KEEP?
OK=YES(EDIT/DEL=NO)

- 5** Using the ◀ and ▶ keys, select either “EDIT” or “DELETE”, and then press the [Yes] key.

*EDIT DELETE
◀,▶ & YES

- If “EDIT” was selected, the specified recipients are displayed in order. (Continue with step 6.)
- If “DELETE” was selected, the program dialing settings are deleted and the “FAX REGISTRATION” menu appears again.

- 6** To delete the displayed recipient, press the [No] key. To keep the displayed recipient, press the [Yes] key.

NO.001=AAA TOKYO
OK=YES (DEL=NO)

The next recipient is displayed.

- 7** When you are finished making changes, press the [Start] key.

- Other program dialing settings can be programmed or changed.

NO.005=_
(Fin.=START)

- 8** Press the [No] key to return to the “FAX REGISTRATION” menu.

-SELECT REGIST.KEY-
(COMPLETE=NO)

To change/delete a programmed timer transmission

- 1** Select the “FAX REGISTRATION” menu.

- Refer to “To select the “FAX REGISTRATION” menu” on page 10-2.

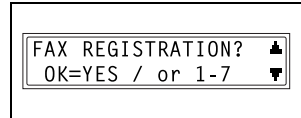

- 2** Press the [4] key from the 10-Key Pad to select “PROGRAM DIAL”.

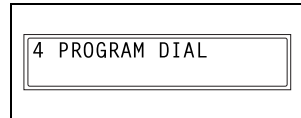

- 3** Press the one-touch dial key ([24] through [27]) programmed with the timer transmission that you wish to change or delete.



- 4** Press the [No] key.



- 5** Using the ◀ and ▶ keys, select either “EDIT” or “DELETE”, and then press the [Yes] key.

- If “EDIT” was selected, the programmed transmission time is displayed. (Continue with step 6.)
- If “DELETE” was selected, the program dialing settings are deleted and the “FAX REGISTRATION” menu appears again.

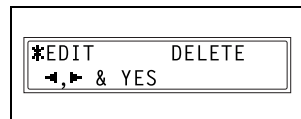

- 6** To change the transmission time, press the [No] key, and then use the 10-Key Pad to enter the correct time.

If you do not wish to change the transmission time, press the [Yes] key.

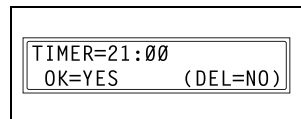

The recipient is displayed.

- 7 To change the recipient, press the [No] key, and then by using the one-touch dial keys or the speed dial numbers, or by entering the fax number using the 10-Key Pad, specify a different recipient.

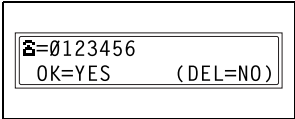

0123456
OK=YES (DEL=NO)

- Change the F codes (sub-address and SID) as desired.

- 8 Press the [Yes] key.

- Other program dialing settings can be changed.

- 9 Press the [No] key to return to the “FAX REGISTRATION” menu.





-SELECT REGIST.KEY-
(COMPLETE=NO)

To change/delete a programmed mailbox transmission

- 1 Select the “FAX REGISTRATION” menu.

- Refer to “To select the “FAX REGISTRATION” menu” on page 10-2.



FAX REGISTRATION? 
OK=YES / or 1-7 

- 2 Press the [4] key from the 10-Key Pad to select “PROGRAM DIAL”.



4 PROGRAM DIAL

- 3 Press the one-touch dial key ([24] through [27]) programmed with the mailbox transmission that you wish to change or delete.



-SELECT REGIST.KEY-

- 4 Press the [No] key.



REGISTERED! KEEP?
OK=YES(EDIT/DEL=NO)

- 5** Using the ◀ and ▶ keys, select either “EDIT” or “DELETE”, and then press the [Yes] key.

- If “EDIT” was selected, the specified recipient is displayed. (Continue with step 6.)
- If “DELETE” was selected, the program dialing settings are deleted and the “FAX REGISTRATION” menu appears again.

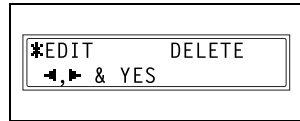

- 6** To change the recipient, press the [No] key, and then by using the one-touch dial keys or the speed dial numbers, or by entering the fax number using the 10-Key Pad, specify a different recipient.

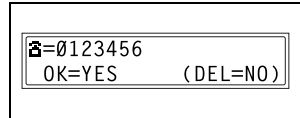

- 7** Press the [Yes] key.

The mailbox ID is displayed.

- 8** To change the mailbox ID, press the [No] key, and then use the 10-Key Pad to enter the new ID.

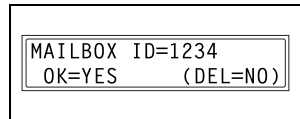

- 9** Press the [Yes] key.

The password is displayed.

- 10** To change the password, press the [No] key, and then use the 10-Key Pad to enter the new password.

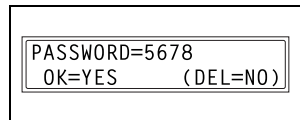

- 11** Press the [Yes] key.

Other program dialing settings can be changed.

- 12** Press the [No] key to return to the “FAX REGISTRATION” menu.

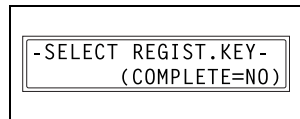

To change/delete a programmed polling reception

- 1 Select the “FAX REGISTRATION” menu.
 - Refer to “To select the “FAX REGISTRATION” menu” on page 10-2.

- 2 Press the [4] key from the 10-Key Pad to select “PROGRAM DIAL”.
 

- 3 Press the one-touch dial key ([24] through [27]) programmed with the polling reception that you wish to change or delete.
 

- 4 Press the [No] key.
 

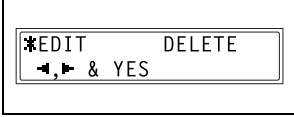
- 5 Using the ◀ and ▶ keys, select either “EDIT” or “DELETE”, and then press the [Yes] key.
 - If “EDIT” was selected, the specified recipients are displayed in order. (Continue with step 6.)
 - If “DELETE” was selected, the program dialing settings are deleted and the “FAX REGISTRATION” menu appears again.

- 6 To delete the displayed recipient, press the [No] key. To keep the displayed recipient, press the [Yes] key.
 - To add a recipient, in the screen containing “Fin.=START”, specify a recipient using the one-touch dial keys or the speed dial numbers, or by entering a fax number using the 10-Key Pad.
The next recipient is displayed.

- 7** When you are finished making changes, press the [Start] key.
Other program dialing settings can be changed.

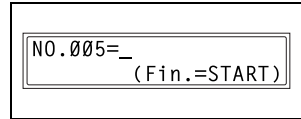

- 8** Press the [No] key to return to the "FAX REGISTRATION" menu.



To change/delete a programmed relay initiation transmission

- 1** Select the "FAX REGISTRATION" menu.
- Refer to "To select the "FAX REGISTRATION" menu" on page 10-2.

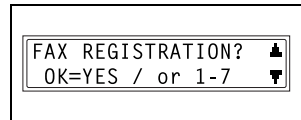

- 2** Press the [4] key from the 10-Key Pad to select "PROGRAM DIAL".

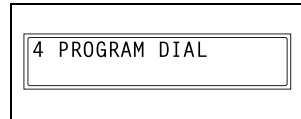

- 3** Press the one-touch dial key ([24] through [27]) programmed with the relay initiation transmission that you wish to change or delete.



- 4** Press the [No] key.

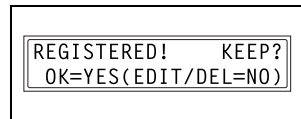

- 5** Using the ◀ and ▶ keys, select either “EDIT” or “DELETE”, and then press the [Yes] key.

- If “EDIT” was selected, the specified recipient is displayed. (Continue with step 6.)
- If “DELETE” was selected, the program dialing settings are deleted and the “FAX REGISTRATION” menu appears again.



```
*EDIT      DELETE
◀, ▶ & YES
```

- 6** To change the recipient, press the [No] key, and then by using the one-touch dial keys or the speed dial numbers, or by entering the fax number using the 10-Key Pad, specify a different recipient.

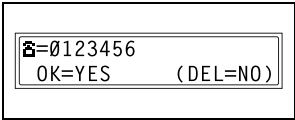

```
☎=0123456
OK=YES      (DEL=NO)
```

- 7** Press the [Yes] key.

The relay box ID is displayed.

- 8** To change the relay box ID, press the [No] key, and then use the 10-Key Pad to enter the new ID.

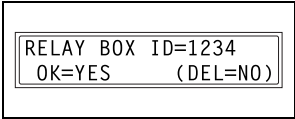

```
RELAY BOX ID=1234
OK=YES      (DEL=NO)
```

- 9** Press the [Yes] key.

The password is displayed.

- 10** To change the password, press the [No] key, and then use the 10-Key Pad to enter the new password.

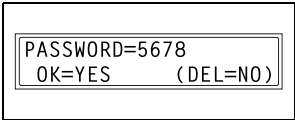

```
PASSWORD=5678
OK=YES      (DEL=NO)
```

- 11** Press the [Yes] key.

Other program dialing settings can be changed.

- 12** Press the [No] key to return to the “FAX REGISTRATION” menu.



```
-SELECT REGIST.KEY-
  (COMPLETE=NO)
```

Setting Up Batch Transmissions (“BATCH TX” function)

If the batch transmission setting (transmission time) is specified for a one-touch dial key programmed with recipient fax numbers, multiple documents can be stored in the memory and sent out together at the specified time.



Note

A one-touch dial key must first be programmed with the fax number of the recipient for the batch transmission.

To set batch transmitting

- 1 Select the “FAX REGISTRATION” menu.

- Refer to “To select the “FAX REGISTRATION” menu” on page 10-2.

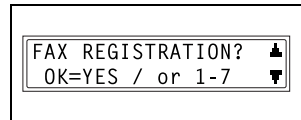

- 2 Press the [5] key from the 10-Key Pad to select “BATCH TX”.

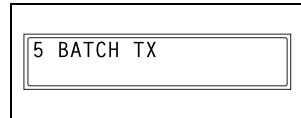

- 3 Press the one-touch dial key programmed with the recipient that you wish to send the batch transmission fax to.

A screen appears, allowing you to specify the transmission time.



? Was the one-touch dial key that was pressed one programmed for group dialing, program dialing, or combination dialing, or not programmed at all?

→ An error message appears.

REGISTERED! GROUP KEEP=YES (DEL=NO)
REGISTERED! PROGRAM KEEP=YES (DEL=NO)
REGISTERED! COMBINE
NOT REGISTERED!

4 Using the 10-Key Pad, enter the desired transmission time, and then press the [Yes] key.

TX TIME=15:30 OK=YES

5 Press the [No] key to return to the "FAX REGISTRATION" menu.

-SELECT REGIST.KEY- (COMPLETE=NO)

To change the batch transmission setting

- 1** Select the “FAX REGISTRATION” menu.

- Refer to “To select the “FAX REGISTRATION” menu” on page 10-2.

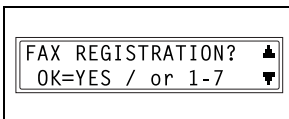

- 2** Press the [5] key from the 10-Key Pad to select “BATCH TX”.

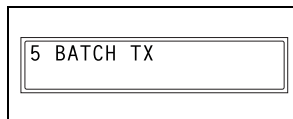

- 3** Press the one-touch dial key programmed with the batch transmission setting that you wish to change.



- 4** Press the [No] key, and then use the 10-Key Pad to enter the new transmission time.

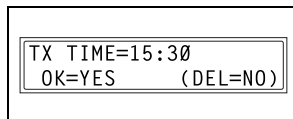

- 5** When you are finished making changes, press the [Yes] key.

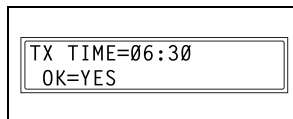

- 6** Press the [No] key to return to the “FAX REGISTRATION” menu.



To delete the batch transmission setting

- 1** Select the “FAX REGISTRATION” menu.

- Refer to “To select the “FAX REGISTRATION” menu” on page 10-2.

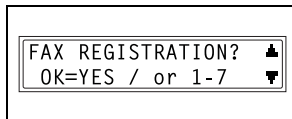

- 2** Press the [5] key from the 10-Key Pad to select “BATCH TX”.

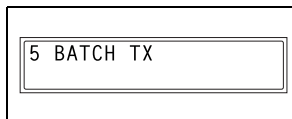

- 3** Press the one-touch dial key programmed with the batch transmission setting that you wish to delete.



- 4** Press the [No] key.

A confirmation message appears, asking whether or not to delete the batch transmission setting.

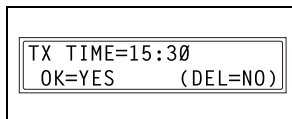

- 5** Press the [Yes] key.

The “FAX REGISTRATION” menu appears again.

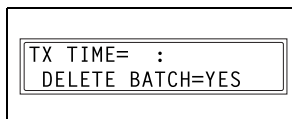

Setting Up Mailboxes (“MAILBOX” function)

Mailbox IDs must first be specified in order to receive faxes with mailbox reception only if the mailbox ID sent by the caller matches the mailbox ID set on this machine.



Note

A mailbox ID cannot be the same as a relay box ID.

To register a mailbox

- 1 Select the “FAX REGISTRATION” menu.

- Refer to “To select the “FAX REGISTRATION” menu” on page 10-2.

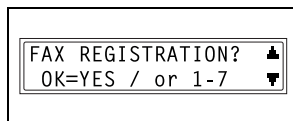

- 2 Press the [6] key from the 10-Key Pad to select “MAILBOX”.

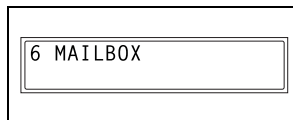

- 3 Using the 10-Key Pad, enter the mailbox number.

- The mailbox number can be set to any number between 0 and 9.

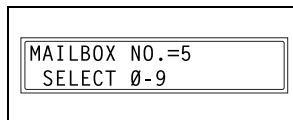

- 4 Using the 10-Key Pad, enter the 4-digit mailbox ID, and then press the [Yes] key.

- The mailbox ID can be set to any number between 0000 and 9999.
- If you wish to change the mailbox ID, press the [No] key, and then enter the new number.

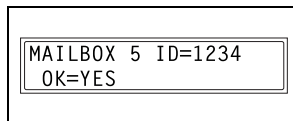

- 5** Using the 10-Key Pad, enter the 4-digit password, and then press the [Yes] key.



PASSWORD=5678
OK=YES



- The password can be set to any number between 0000 and 9999.
- If you wish to change the password, press the [No] key, and then enter the new password.
- If no password is to be specified, press the [Yes] key without entering anything.

The “FAX REGISTRATION” menu appears again.

To delete a mailbox

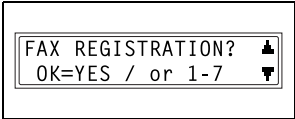
- 1** Select the “FAX REGISTRATION” menu.



FAX REGISTRATION? 
OK=YES / or 1-7 

- Refer to “To select the “FAX REGISTRATION” menu” on page 10-2.

- 2** Press the [6] key from the 10-Key Pad to select “MAILBOX”.



6 MAILBOX

- 3** Using the 10-Key Pad, enter the number of the mailbox that you wish to delete.



MAILBOX NO.=5
SELECT 0-9

- 4** Press the [No] key.

A screen appears, allowing you to enter the mailbox ID.



REGISTERED! KEEP?
KEEP=YES (DEL=NO)

- 5 Using the 10-Key Pad, enter the 4-digit mailbox ID, and then press the [Yes] key.

- If you wish to change the ID, press the [No] key, and then enter the new number.

The specified mailbox is deleted.

OLD M-BOX5 ID=1234
OK=YES

- 6 Press the [Panel Reset] key.

The main screen appears again.

MAILBOX NO.=_
SELECT 0-9

Setting Up Relay Boxes (“RELAY BOX” function)

A relay box ID must first be set in order for this machine (acting as a relay station) to receive a document from another fax machine (transmitting station), then transmit the document to multiple recipients (receiving stations).



Note

A relay box ID cannot be the same as a mailbox ID.

This machine (acting as a relay station) can be set to send back a relay result report. The fax number of the recipient of the report (either the transmitting station or any other recipient) must be specified using either the one-touch dial keys or a speed dial number. Therefore, before using this function, be sure that a one-touch dial key or a speed dial number is programmed with the fax number of the report recipient.

To program the relay box

- 1** Select the “FAX REGISTRATION” menu.

- Refer to “To select the “FAX REGISTRATION” menu” on page 10-2.

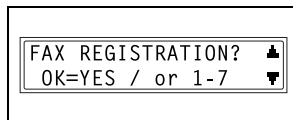

- 2** Press the [7] key from the 10-Key Pad to select “RELAY BOX”.

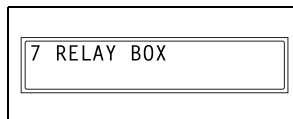

- 3** Using the 10-Key Pad, enter the relay box number.

- The relay box number can be set to any number between 1 and 5.

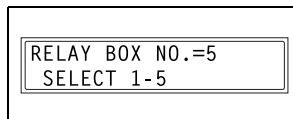

- 4** Using the 10-Key Pad, enter the 4-digit relay box ID, and then press the [Yes] key.

- The relay box ID can be set to any number between 0000 and 9999.
- If you wish to change the relay box ID, press the [No] key, and then enter the new number.

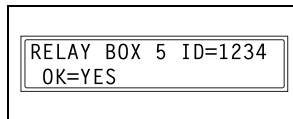

- 5** Using the 10-Key Pad, enter the 4-digit password, and then press the [Yes] key.

- The password can be set to any number between 0000 and 9999.
- If you wish to change the password, press the [No] key, and then enter the new password.
- If no password is to be specified, press the [Yes] key without entering anything.

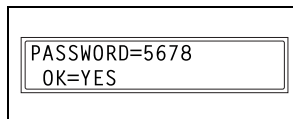

- 6** To send back a relay result report, specify the recipient using either a one-touch dial key or speed dial number programmed with the recipient's fax number.

A screen appears, allowing you to specify the receiving stations.

REPORT=SPEED DIAL001
OK=YES

REPORT=AAA OSAKA
OK=YES

- 7** Using the one-touch dial keys or the speed dial numbers, or by entering the fax number using the 10-Key Pad, specify a receiving station, and then press the [Yes] key.

- A maximum of 50 recipients can be specified as receiving stations. Repeat this step until all desired receiving stations are specified.

- To delete the currently selected recipient, press the [No] key.

NO.001=ONE-TOUCH 01

NO.001=AAA TOKYO
OK=YES (Fin.=START)

- 8** When you are finished specifying all receiving stations, press the [Start] key.

The "FAX REGISTRATION" menu appears again.

NO.005=_
(Fin.=START)

To delete the relay box

- 1** Select the “FAX REGISTRATION” menu.

- Refer to “To select the “FAX REGISTRATION” menu” on page 10-2.

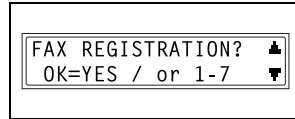

- 2** Press the [7] key from the 10-Key Pad to select “RELAY BOX”.

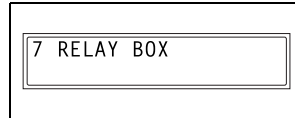

- 3** Using the 10-Key Pad, enter the number of the relay box that you wish to delete.

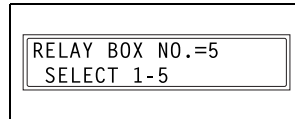

- 4** Press the [No] key.

The specified relay box is deleted.
To delete another relay box, repeat steps 3 and 4.

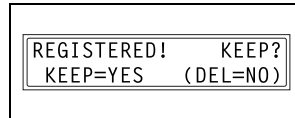

- 5** Press the [Panel Reset] key.

The main screen appears again.

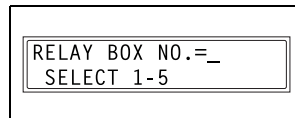

10.2 Specifying Transmission Settings (“TX OPERATION” Menu)

From the “TX OPERATION” menu, various functions for sending faxes can be set.

“TX OPERATION” menu:

No.	TX OPERATION	Characteristic/Description
1	SCAN CONTRAST	This function can be used to set the default scanning contrast level to one of five settings between “LIGHT” and “DARK”. For dark-colored paper (media), select a setting towards “LIGHT”. For faint or colored text, select a setting toward “DARK”.
2	RESOLUTION	This function can be used to set the default scanning resolution (image quality) to one of the following: “Standard”, “Fine”, “Super Fine”, “Half Tone + Standard”, “Half Tone + Fine” or “Half Tone + Super Fine”. • The manufacturer’s default setting is “Standard”.
3	DEFAULT TX	This function can be used to set the default transmission mode to “MEM.TX” or “ADF TX”. • The manufacturer’s default setting is “MEM.TX”.
4	HEADER	This function cannot be set on this machine. (Printing of the name of the transmission source on the edge of the document transmitted is fixed by the settings.)
5	OT-DIAL IN COPY	This function can be used to specify whether or not faxing is possible by pressing a one-touch dial key while the machine is in Copy mode. • The manufacturer’s default setting is “DISABLE”.

To select the “TX OPERATION” menu

- 1 Press the [Utility] key.

The first screen of the Utility mode appears.

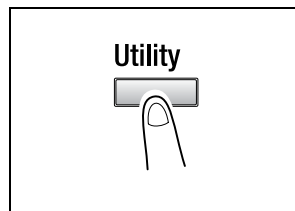

- 2 Press the ▼ key 7 times to select “TX OPERATION”.

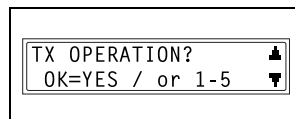

- 3** From the 10-Key Pad, press the key ([1] through [5]) for the “TX OPERATION” function that you wish to set.
- The “TX OPERATION” functions are as follows:
 - 1 SCAN CONTRAST
 - 2 RESOLUTION
 - 3 DEFAULT TX
 - 4 HEADER
 - 5 OT-DIAL IN COPY

**Tip**

If, at any time, you wish to quit setting a “TX OPERATION” function, press the [No] key. When the message “STOP SETTING?” appears, press the [Yes] key to quit.

To specify the default scanning contrast (“SCAN CONTRAST” function)

- 1** Select the “TX OPERATION” menu.

- Refer to “To select the “TX OPERATION” menu” on page 10-35.

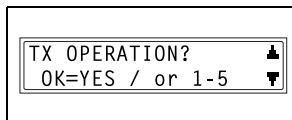

- 2** Press the [1] key from the 10-Key Pad to select “SCAN CONTRAST”.



- 3** Using the ◀ and ▶ keys, select one of the five settings between “LIGHT” and “DARK”, and then press the [Yes] key.

The “TX OPERATION” menu appears again.

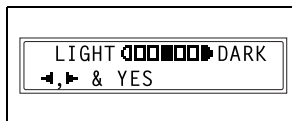

To specify the default resolution setting (“RESOLUTION” function)**1** Select the “TX OPERATION” menu.

- Refer to “To select the “TX OPERATION” menu” on page 10-35.

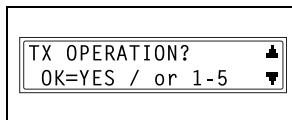
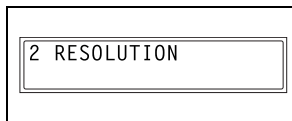
**2** Press the [2] key from the 10-Key Pad to select “RESOLUTION”.**3** Using the ◀ and ▶ keys, select the desired resolution setting, and then press the [Yes] key.

- The resolution settings appear as follows.
 STD: Standard
 FINE: Fine
 S/F: Super Fine
 H/T: Half Tone

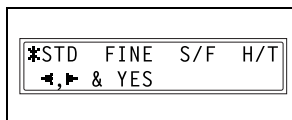

If “H/T” was selected, a screen appears, allowing you to make a detailed setting. (Continue with step 4.) If any setting other than “H/T” was selected, the “TX OPERATION” menu appears again.

4 Using the ◀ and ▶ keys, select the desired halftone setting, and then press the [Yes] key.

- The halftone settings appear as follows.
 STD: Standard
 FINE: Fine
 S/F: Super Fine

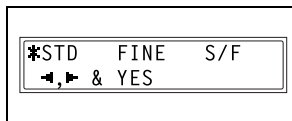

The “TX OPERATION” menu appears again.

To set the “DEFAULT TX” function

About memory transmission:

- ✓ Memory transmission is only available when the optional Automatic Document Feeder is installed.

1 Select the “TX OPERATION” menu.

- Refer to “To select the “TX OPERATION” menu” on page 10-35.

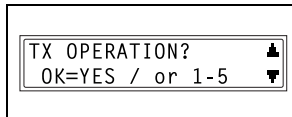

2 Press the [3] key from the 10-Key Pad to select “DEFAULT TX”.

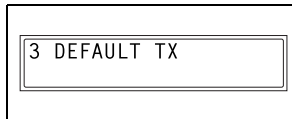

3 Using the ◀ and ▶ keys, select either “MEM.TX” or “ADF TX”, and then press the [Yes] key.

The “TX OPERATION” menu appears again.

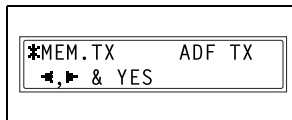

To specify if one-touch dialing transmission (Copy mode) is allowed (“OT-DIAL IN COPY” function)

1 Select the “TX OPERATION” menu.

- Refer to “To select the “TX OPERATION” menu” on page 10-35.

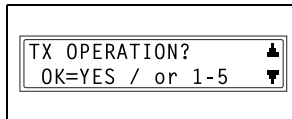

2 Press the [5] key from the 10-Key Pad to select “OT-DIAL IN COPY”.

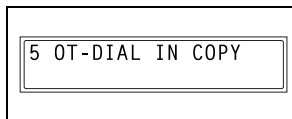

3 Using the ◀ and ▶ keys, select either “DISABLE” or “ENABLE”, and then press the [Yes] key.

The “TX OPERATION” menu appears again.

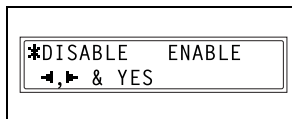

10.3 Specifying Reception Settings (“RX OPERATION” Menu)

From the “RX OPERATION” menu, various functions for receiving faxes can be set.

“RX OPERATION” menu:

No.	RX OPERATION	Characteristic/Description
1	MEMORY RX MODE	<p>This function can be used to set whether to allow (“ON”) memory reception or not (“OFF”). In cases when confidential faxes are being received, the received document can be stored in the memory and printed at a specified time or when memory reception is set to “OFF”.</p> <p>A password can be set to specify the starting time or ending time of memory reception, or to cancel the function. The set starting time and ending time are valid every day until memory reception is turned off.</p> <ul style="list-style-type: none"> • The manufacturer’s default setting is “OFF”.
2	No. of RINGS	<p>This function can be used to set the number of rings between 1 and 16 until the call is answered.</p>
3	REDUCTION RX	<p>This function can be used to set whether documents longer than the paper are printed reduced (“ON”), split (“OFF”), or discarded (“CUT”).</p> <ul style="list-style-type: none"> • The manufacturer’s default setting is “ON”.
4	RX PRINT	<p>This function can be used to set whether the fax is only printed after all document pages have been received (“MEMORY RX”) or printing begins as soon as the first page of the document is received (“PRINT RX”).</p> <ul style="list-style-type: none"> • The manufacturer’s default setting is “MEMORY RX”.
5	RX MODE	<p>This function can be used to set the reception mode to automatic reception (“AUTO RX”) or manual reception (“MANUAL RX”).</p> <p>Automatic reception: Automatically begins receiving after the set number of rings.</p> <p>Manual reception: Does not automatically receive the fax. Reception begins after making a connection by picking up the telephone receiver or pressing the [Speaker] key, then pressing the [Start] key.</p> <ul style="list-style-type: none"> • The manufacturer’s default setting is “AUTO RX”.
6	FORWARD	<p>This function can be used to set whether or not the received document is forwarded.</p> <p>Forward (“ON”): The received document is forwarded to the specified fax number or e-mail address.</p> <p>Forward and print (“ON(PRINT)”): The received document is printed by this machine at the same time that it is forwarded to the specified fax number or e-mail address.</p> <p>Do not forward (“OFF”): The document is not forwarded</p> <ul style="list-style-type: none"> • The manufacturer’s default setting is “OFF”. * In order to forward the document to an e-mail address, the optional Internet Fax & Network scan kit is required.

No.	RX OPERATION	Characteristic/Description
7	FOOTER	This function can be used to set whether or not the reception information (date received, number of pages, etc.) is printed at the bottom of each received document. <ul style="list-style-type: none">• The manufacturer's default setting is "OFF".
8	SELECT TRAY	This function can be used to select which paper tray can be used to supply paper when printing received documents or transmission reports. (A paper tray that cannot be used for supplying paper can also be specified.) This function is only available when an optional paper tray is installed.

To select the “RX OPERATION” menu

- 1 Press the [Utility] key.

The first screen of the Utility mode appears.

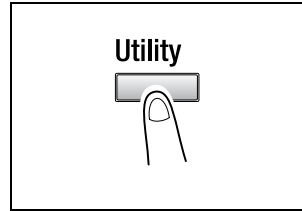

- 2 Press the ▼ key 8 times to select “RX OPERATION”.

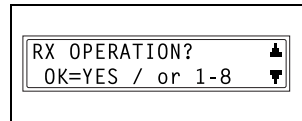

- 3 From the 10-Key Pad, press the key ([1] through [8]) for the “RX OPERATION” function that you wish to set.
 - The “RX OPERATION” functions are as follows:
 - 1 MEMORY RX MODE
 - 2 NO.of RINGS
 - 3 REDUCTION RX
 - 4 RX PRINT
 - 5 RX MODE
 - 6 FORWARD
 - 7 FOOTER
 - 8 SELECT TRAY



Tip

If, at any time, you wish to quit setting/changing an “RX OPERATION” function, press the [No] key. When the message “STOP SETTING?” appears, press the [Yes] key to quit.

To exit the “RX OPERATION” menu, press the [Panel Reset] key. The main screen appears again.

To select the memory reception mode (“MEMORY RX MODE” function)

- 1 Select the “RX OPERATION” menu.

- Refer to “To select the “RX OPERATION” menu” on page 10-41.

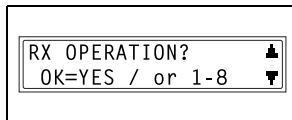

- 2 Press the [1] key from the 10-Key Pad to select “MEMORY RX MODE”.

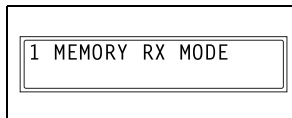

- 3 Using the ◀ and ▶ keys, select “ON”, and then press the [Yes] key.

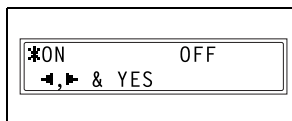

- 4 Using the 10-Key Pad, enter the time for memory reception to begin, and then press the [Yes] key.

- To specify that memory reception stays on from the time that it is set to “ON” until it is manually cancelled, press the [Yes] without entering a start time. (Skip to step 6.)

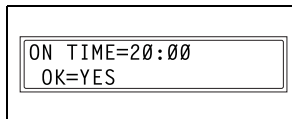

- 5 Using the 10-Key Pad, enter the time for memory reception to end, and then press the [Yes] key.

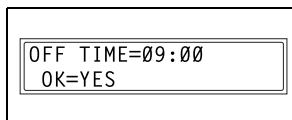

- 6 Using the 10-Key Pad, enter the 4-digit password used to cancel memory reception, and then press the [Yes] key.

- If no password is to be specified, press the [Yes] key without entering anything.

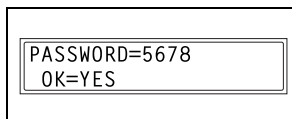

The “RX OPERATION” menu appears again.

To cancel memory reception

Memory reception is automatically cancelled at the specified ending time, and the received documents are printed. If no ending time has been set or if you wish to cancel memory reception before the ending time, follow the procedure described below.

1 Select the “RX OPERATION” menu.

- Refer to “To select the “RX OPERATION” menu” on page 10-41.

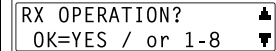

RX OPERATION? ▲
OK=YES / or 1-8 ▼

2 Press the [1] key from the 10-Key Pad to select “MEMORY RX MODE”.



1 MEMORY RX MODE

3 Using the ◀ and ▶ keys, select “OFF”, and then press the [Yes] key.

- If a password was specified, continue with step 4.
- If a password was not specified, all received documents stored in the memory are printed, and the “RX OPERATION” menu appears again.



ON *OFF
◀, ▶ & YES

4 Using the 10-Key Pad, enter the 4-digit password, and then press the [Yes] key.



PASSWORD=5678
OK=YES

All received documents stored in the memory are printed, and the “RX OPERATION” menu appears again.

To set the “NO.of RINGS” function

1 Select the “RX OPERATION” menu.

- Refer to “To select the “RX OPERATION” menu” on page 10-41.

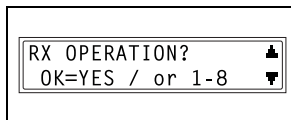

2 Press the [2] key from the 10-Key Pad to select “NO.of RINGS”.

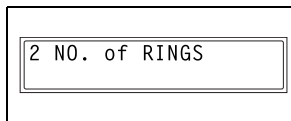

3 Using the 10-Key Pad, enter the desired number of rings, and then press the [Yes] key.

- The number of rings can be set between 1 and 16.

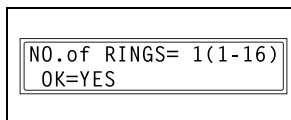

The “RX OPERATION” menu appears again.

To set the “REDUCTION RX” function

1 Select the “RX OPERATION” menu.

- Refer to “To select the “RX OPERATION” menu” on page 10-41.

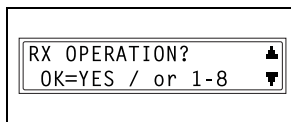

2 Press the [3] key from the 10-Key Pad to select “REDUCTION RX”.

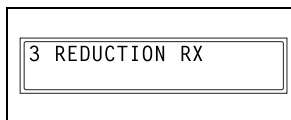

3 Using the ◀ and ▶ keys, select “ON” (print the document reduced), “OFF” (split the printout) or “CUT” (discard any excess), and then press the [Yes] key.

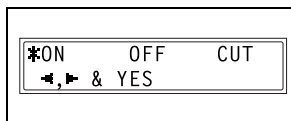

The “RX OPERATION” menu appears again.

To set the “RX PRINT” function**1** Select the “RX OPERATION” menu.

- Refer to “To select the “RX OPERATION” menu” on page 10-41.

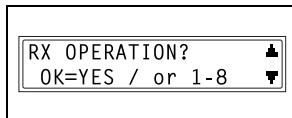
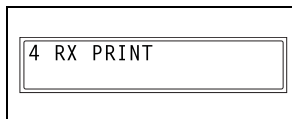
**2** Press the [4] key from the 10-Key Pad to select “RX PRINT”.**3** Using the ◀ and ▶ keys, select either “MEMORY RX” or “PRINT RX”, and then press the [Yes] key.

The “RX OPERATION” menu appears again.

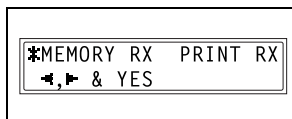
**To set the “RX MODE” function****1** Select the “RX OPERATION” menu.

- Refer to “To select the “RX OPERATION” menu” on page 10-41.

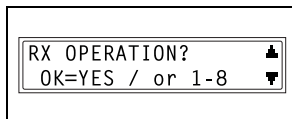
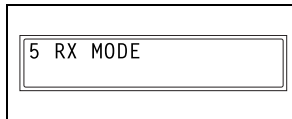
**2** Press the [5] key from the 10-Key Pad to select “RX MODE”.**3** Using the ◀ and ▶ keys, select either “AUTO RX” or “MANUAL RX”, and then press the [Yes] key.

The “RX OPERATION” menu appears again.

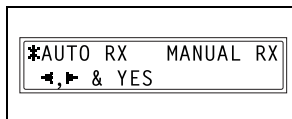

To set the “FORWARD” function

1 Select the “RX OPERATION” menu.

- Refer to “To select the “RX OPERATION” menu” on page 10-41.

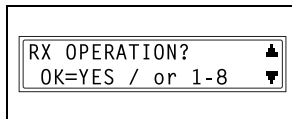

2 Press the [6] key from the 10-Key Pad to select “FORWARD”.

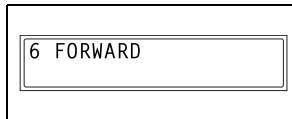

3 Using the ◀ and ▶ keys, select “ON”, “ON(PRINT)” or “OFF”, and then press the [Yes] key.

- If “ON” or “ON(PRINT)” was selected, a screen appears, allowing you to specify the forwarding location. (Continue with step 4.)
- If “OFF” was selected, the “RX OPERATION” menu appears again.

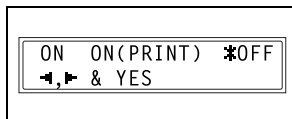

4 Using the one-touch dial keys or the speed dial numbers, or by entering the fax number using the 10-Key Pad, specify a fax number, and then press the [Yes] key.

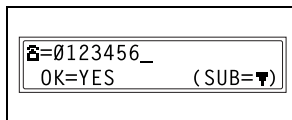

The “RX OPERATION” menu appears again.



Tip

An e-mail address can be specified as a forwarding location only when the optional Internet Fax & Network scan kit is installed.

To set the “FOOTER” function**1** Select the “RX OPERATION” menu.

- Refer to “To select the “RX OPERATION” menu” on page 10-41.

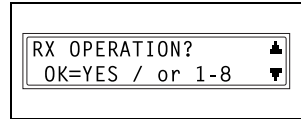
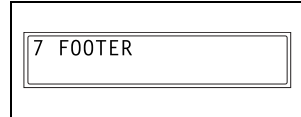
**2** Press the [7] key from the 10-Key Pad to select “FOOTER”.**3** Using the ◀ and ▶ keys, select either “ON” or “OFF”, and then press the [Yes] key.

The “RX OPERATION” menu appears again.

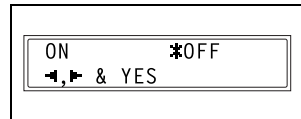
**To set the “SELECT TRAY” function****1** Select the “RX OPERATION” menu.

- Refer to “To select the “RX OPERATION” menu” on page 10-41.

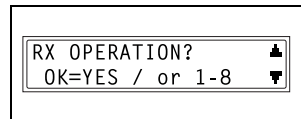
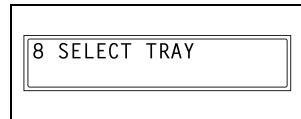
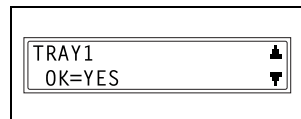
**2** Press the [8] key from the 10-Key Pad to select “SELECT TRAY”.**3** Using the ◀ and ▶ keys, select a paper tray, and then press the [Yes] key.**4** Using the ◀ and ▶ keys, select either “DISABLE” or “ENABLE”, and then press the [Yes] key.

The “RX OPERATION” menu appears again.

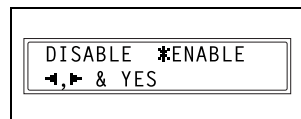

10.4 Specifying Communication Settings (“COMM.SETTING” Menu)

From the “COMM.SETTING” menu, various functions are available for specifying communication settings.

“COMM.SETTING” menu:

No.	COMM.SETTING	Characteristic/Description
1	TONE/PULSE	This function can be used to specify the dialing system. If this function is not correctly set to the type of dialing system used, faxes cannot be sent. Select the correct setting after checking which type of dialing system is used by your telephone line. For details on setting this function, refer to “Specifying the Phone Dialing System” on page 3-34.
2	LINE MONITOR	This function can be used to set the volume when monitoring communication to “HIGH”, “LOW” or “OFF”. • The manufacturer’s default setting is “LOW”.
3	PSTN/PBX	This function can be used to set whether the connected telephone wiring is a public switched telephone network (PSTN) or a private branch exchange (PBX). For a PBX system, the outside line access number (or extension number) must be specified.

For details on setting the “TONE/PULSE” and “PSTN/PBX” functions, refer to “Specifying the Phone Dialing System” on page 3-34 and “Specifying the Phone Wiring System” on page 3-35.

To set the “LINE MONITOR” function

- 1** Press the [Utility] key.

The first screen of the Utility mode appears.

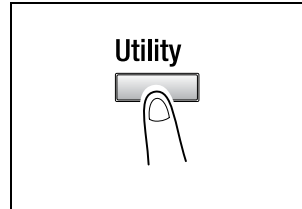

- 2** Press the ▼ key 9 times to select “COMM.SETTING”.

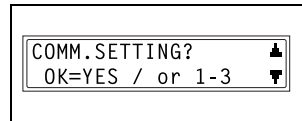

- 3** From the 10-Key Pad, press the [2] key.

A screen appears, allowing you to select the monitoring volume.



- 4** Using the ◀ and ▶ keys, select “HIGH”, “LOW” or “OFF”, and then press the [Yes] key.

The “COMM.SETTING” menu appears again.

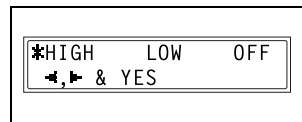

10.5 Specifying Report Output (“REPORTING” Menu)

From the “REPORTING” menu, various functions are available for specifying which reports are automatically printed.

“REPORTING” menu:

No.	REPORTING	Characteristic/Description
1	ACTIVITY REPORT	Every 60 transmissions/receptions, a report can be printed to show the results of the transmissions/receptions. This function can be used to set whether the report is printed automatically when the 60th transmission/reception is reached. <ul style="list-style-type: none"> The manufacturer’s default setting is “ON”.
2	RESERV.REPORT	If multiple recipients are specified for transmission, such as with broadcast transmission and polling reception, a report can be printed to show specified settings. This function can be used to set whether this report is printed automatically. <ul style="list-style-type: none"> The manufacturer’s default setting is “OFF”.
3	TX RESULT REPORT	This function can be used to set whether the report showing the result of a transmission is printed automatically after the transmission is finished. <ul style="list-style-type: none"> The manufacturer’s default setting is “OFF”.
4	RX RESULT REPORT	This function can be used to set whether the report showing the result of a reception is printed automatically after mailbox reception is finished. (If regular reception is not finished normally, a report will always be printed, regardless of the selected setting.) <ul style="list-style-type: none"> The manufacturer’s default setting is “OFF”.

To select the “REPORTING” menu

- Press the [Utility] key.
The first screen of the Utility mode appears.

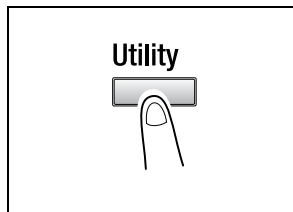

- Press the ▼ key 10 times to select “REPORTING”.

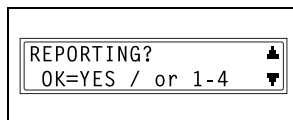

- 3** From the 10-Key Pad, press the key ([1] through [4]) for the “REPORTING” function that you wish to set.
- The “REPORTING” functions are as follows:
 - 1 ACTIVITY REPORT
 - 2 RESERV.REPORT
 - 3 TX RESULT REPORT
 - 4 RX RESULT REPORT



Tip

*If, at any time, you wish to quit setting/changing a “REPORTING” function, press the [No] key. When the message “STOP SETTING?” appears, press the [Yes] key to quit.
To exit the “REPORTING” menu, press the [Panel Reset] key. The main screen appears again.*

To set the “ACTIVITY REPORT” function

- 1** Select the “REPORTING” menu.

- Refer to “To select the “REPORTING” menu” on page 10-50.

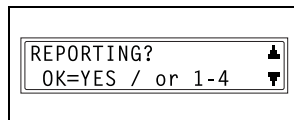

- 2** Press the [1] key from the 10-Key Pad to select “ACTIVITY REPORT”.

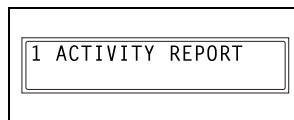

- 3** Using the ◀ and ▶ keys, select either “ON” or “OFF”, and then press the [Yes] key.

The “REPORTING” menu appears again.

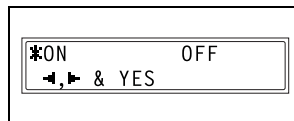

To set the “RESERV.REPORT” function

- 1** Select the “REPORTING” menu.

- Refer to “To select the “REPORTING” menu” on page 10-50.

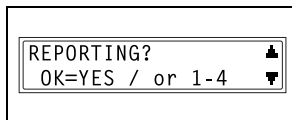

- 2** Press the [2] key from the 10-Key Pad to select “RESERV.REPORT”.

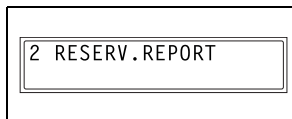

- 3** Using the ◀ and ▶ keys, select either “ON” or “OFF”, and then press the [Yes] key.

The “REPORTING” menu appears again.

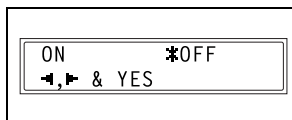
**To set the “TX RESULT REPORT” function**

- 1** Select the “REPORTING” menu.

- Refer to “To select the “REPORTING” menu” on page 10-50.

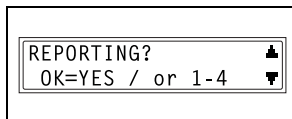

- 2** Press the [3] key from the 10-Key Pad to select “TX RESULT REPORT”.

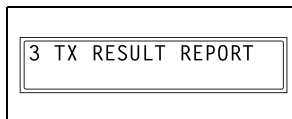

- 3** Using the ◀ and ▶ keys, select either “ON” or “OFF”, and then press the [Yes] key.

The “REPORTING” menu appears again.

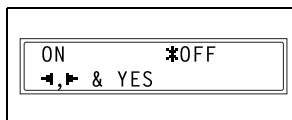

To set the “RX RESULT REPORT” function**1** Select the “REPORTING” menu.

- Refer to “To select the “REPORTING” menu” on page 10-50.

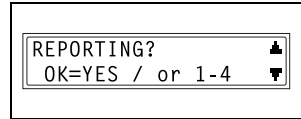
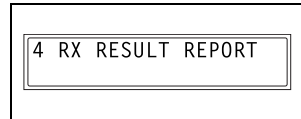
**2** Press the [4] key from the 10-Key Pad to select “RX RESULT REPORT”.**3** Using the ◀ and ▶ keys, select either “ON” or “OFF”, and then press the [Yes] key.

The “REPORTING” menu appears again.

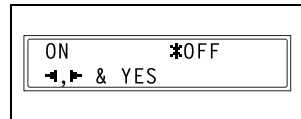

11 Confirmation Mode

11.1 Checking Transmission Results

The transmission result information for a maximum of 60 sent and received documents is saved. For details on checking the transmission results, refer to “To check the transmission result” on page 6-22.

11.2 Checking the Machine’s Counters (“MACHINE COUNTER” Menu)

The number of operations performed since this machine was installed can be checked using the functions available when the [Confirm] key is pressed.

Items that can be checked with “MACHINE COUNTER”:

MACHINE COUNTER	Description
TOTAL COUNT	This count shows the total number of prints made since this machine was installed.
SIZE COUNT	This count shows the total number of prints made for the specified paper size. (The paper size that is counted should be set by the service representative.)
TOTAL SCAN	This count shows the total number of scans made since this machine was installed.
TX PAGES	This count shows the total number of pages faxed since this machine was installed.
RX PAGES	This count shows the total number of fax pages received since this machine was installed.

To check the counters

- 1 Press the [Confirm] key twice, and then press the [Yes] key.

The “MACHINE COUNTER” menu appears.

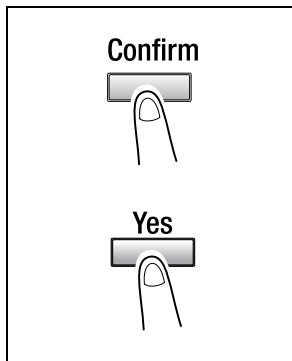

- 2 Using the ▲ and ▼ keys, select the counter that you wish to check.

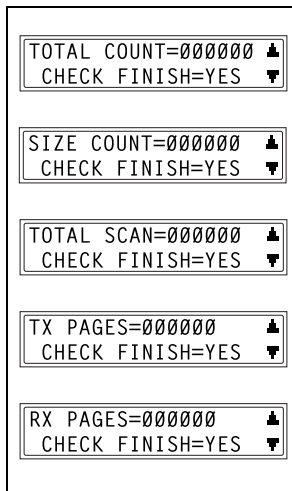

- 3 Press the [Yes] key to return to the “MACHINE COUNTER” menu.
- 4 Press the [No] key to return to the main screen.

11.3 Outputting a report/list (“PRINT REPORT” menu)

The various reports and lists of programmed settings can be printed using the functions available when the [Confirm] key is pressed.

To output a report/list

- 1 Press the [Confirm] key 3 times.

A confirmation message appears, asking whether or not to print a report.

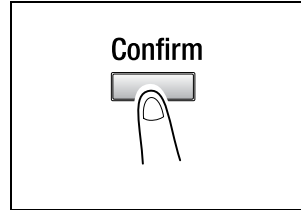

- 2 Press the [Yes] key.

A menu appears, showing the reports and lists that can be printed.

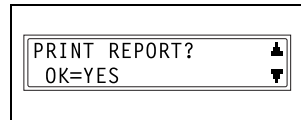

- 3 Using the ▲ and ▼ keys, select the report/list that you wish to print, and then press the [Yes] key.

After the specified report/list is printed, the main screen appears again.

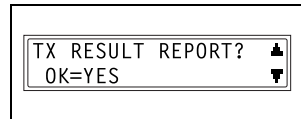

Tip

The reception/transmission result reports can be checked on screen. For details on viewing the transmission result, refer to “To check the transmission result” on page 6-22.

The following reports and lists can be printed.

Transmission Result Report

The document number, recipient name, date sent, starting time of transmission, number of document pages, time required, mode, and transmission result are printed.

SESSION	FUNCTION	No.	DESTINATION STATION	DATE	TIME	PAGE	DURATION	MODE	RESULT
0001	TX	001	AAA NEWYORK 012345678	APR.19	18:00	010	00h02min21s	G3	NG
			NG PAGE:1.3.5.7						

Reception Result Report

The document number, caller name, date received, starting time of reception, number of pages received, time required, mode, and reception result are printed.

SESSION	FUNCTION	No.	DESTINATION STATION	DATE	TIME	PAGE	DURATION	MODE	RESULT
0001	RX	001	AAA TOKYO 098765432	APR.19	18:00	001	00h02min21s	ECM	NG
			0021:ERROR DURING RX						

Activity Report

The operation number, document number, date of operation, starting time of transmission/reception, type of operation (transmission or reception), recipient/caller name, number of pages sent/received, mode, and transmission/reception result are printed.

The machine can also be set to print this report automatically after every 60 transmissions/receptions.

No.	SESSION	DATE	TIME	TX/RX	DESTINATION STATION	PAGE	DURATION	MODE	RESULT
01	0001	APR.19	16:32	TX---	AAA NEWYORK 012345678	006	00h01min16s	ECM	OK
02	0002	APR.19	18:00	---RX	AAA TOKYO 098765432	001	00h02min21s	ECM	NG
03	0002	APR.19	18:00	---RX	AAA TOKYO 098765432	012	00h02min48s	ECM	OK
04	0003	APR.19	19:12	TX---	HEAD OFFICE 024682468	001	00h00min56s	ECM	OK

Queued Job List

This is a list of documents stored in the memory and waiting to be sent, and documents specified for timer transmission, batch transmission or polling reception.

The document number, type of operation being performed, time, recipient/caller name, and number of document pages are printed.

Queued Job Images

A reduced image of the first page of the document stored in the memory and waiting to be sent in addition to the document number, type of operation being performed, recipient/caller name, date, time, and number of document pages are printed.

List of One-Touch Dial Keys

The recipients programmed in the one-touch dial keys are printed in numerical order of the keys.

OT-NO.	DESTINATION STATION	DESTINATION NUMBER	BATCH TIME	SPEED	SET DATE
OT-01	AAA NEWYORK	012345678		33.6	JAN.20.2001
OT-02	AAA TOKYO	098765432		14.4	JAN.20.2001
OT-03	HEAD OFFICE	024682468	16:00	33.6	FEB.12.2001
OT-04	NJ OFFICE	0P02345678 SUB:#1234		14.4	FEB.12.2001

List of Speed Dial Numbers

The recipients programmed for the speed dial numbers are printed in numerical order.

SP-NO.	DESTINATION STATION	DESTINATION NUMBER	SPEED	SET DATE
SP-001	AMSTERDAM OFFICE	0P09876543	33.6	JAN.20'2001
SP-002	KOREA OFFICE	0P01357913	14.4	JAN.20'2001
SP-003	ABCDEF	024682468	33.6	FEB12'2001
SP-004	POST OFFICE	0224466880 SUB:#5678	14.4	FEB12'2001

List of Programmed Keys

The group dialing and program dialing settings specified for one-touch dial keys are printed in numerical order of the keys.

Relay Box List

The status and settings for the 5 relay boxes can be printed and checked.

Machine Settings List

The current machine settings are printed.

Configuration Page

This function is only available when the Printer Controller (optional) is installed.

The list of the printer settings is printed.

PCL Font List

This function is only available when the Printer Controller (optional) is installed.

The PCL font list is printed.

12 Error Messages

12.1 When the Message “LOAD PAPER” Appears

When the currently selected paper tray runs out of paper, the message shown below appears, and copying and printing cannot be performed.

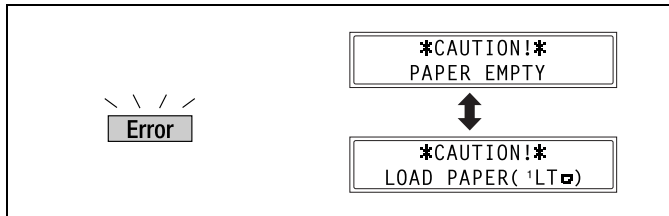

The paper source and paper size appear in the bottom line of the screen. (For the sample message shown above, supply Letter L-size paper into the 1st Tray.)

Check the message for the empty paper tray and the paper size, and then load paper according to the corresponding procedure described below.

To load paper into the 1st Tray

1 Pull out the 1st Tray.

? *Have the necessary precautions been observed when pulling out the tray?*

- Be careful not to touch the surface of the Paper Take-up Roller with your hands.

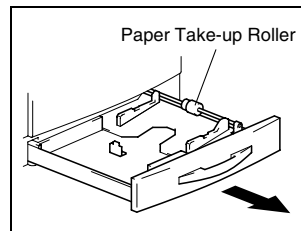

- 2 Press down on the Paper-Lifting Plate until it locks into place.

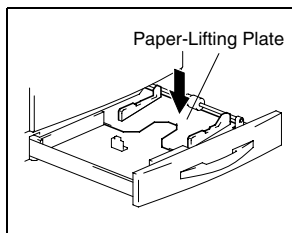

- 3 Load the paper into the tray so that the front side of the paper (the side facing up when the package was unwrapped) faces up.

? *Have the necessary precautions been observed when loading the paper?*

- Do not load so many much paper that the top of the stack is higher than the ▼ mark.

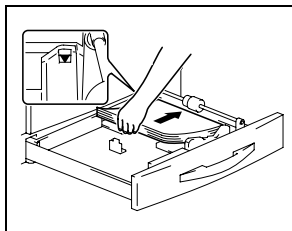

- 4 Slide the paper guides against the edges of the paper.

? *Is the paper guide positioned correctly?*

- Make sure that the paper guides are pushed up against the edges of the paper.

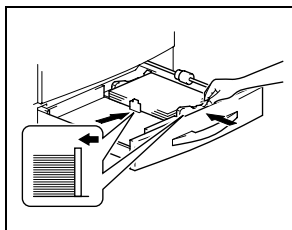

- 5 Close the paper tray.

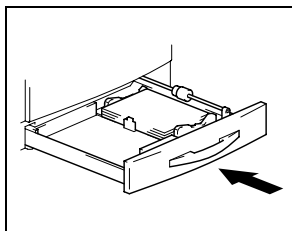

To load paper into the 2nd Tray

Load paper into the 3rd, 4th and 5th paper trays using the same procedure described below.

- 1 Pull out the 2nd Tray.

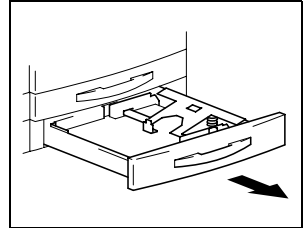

- 2 Press down on the Paper-Lifting Plate until it locks into place.

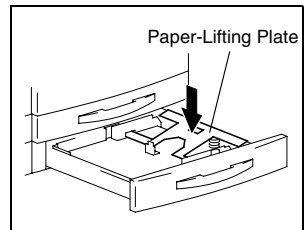

- 3 Load the paper into the tray so that the front side of the paper (the side facing up when the package was unwrapped) faces up.

? *Have the necessary precautions been observed when loading the paper?*

- Do not load so many much paper that the top of the stack is higher than the ▼ mark.

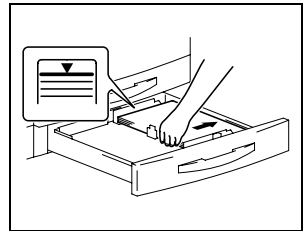

- 4 Slide the paper guides against the edges of the paper.

? *Is the paper guide positioned correctly?*

- Make sure that the paper guides are pushed up against the edges of the paper.

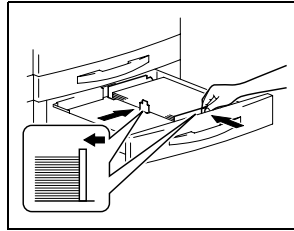

- 5 Close the paper tray.

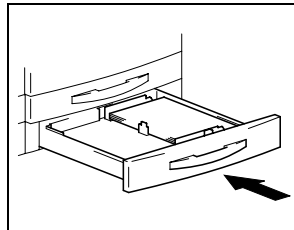

To load paper into the Multiple Bypass Tray

- 1 Load the paper into the Bypass Tray.

? *Have the necessary precautions been observed when loading the paper?*

- Load the paper so that the front side of the paper faces down.
- Do not load so many much paper that the top of the stack is higher than the ▼ mark.
- Make sure that the paper is not curled (rolled).

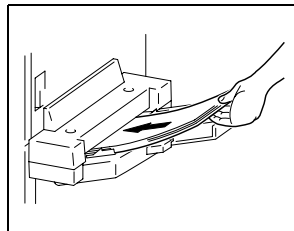

- 2 Adjust the Bypass Tray Extender and the paper guides to fit the size of the paper.

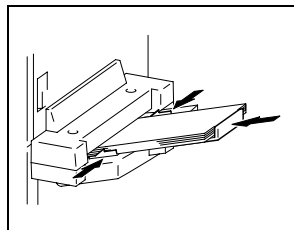

12.2 When the Message “TONER EMPTY” Appears

When toner is about to run out, the message shown below appears.

When this message appears, replace the toner bottle with a new one.

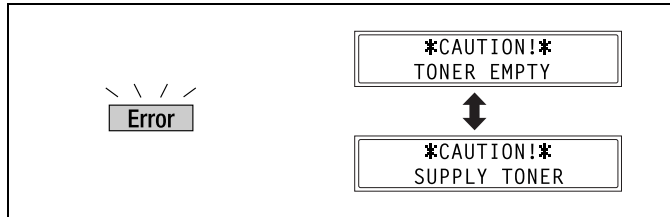

Note

Use only toner developed specifically for this machine. Use of any other type of toner may cause damage to the machine. For details, contact your service representative.

Do not throw away the used toner bottle. Instead, keep it so that it can be collected by your service representative.

To replace the toner bottle

- 1 Open the Front Cover.

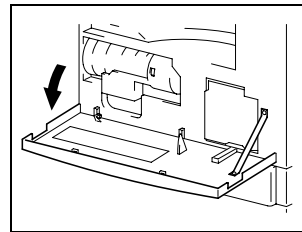

- 2 Swing out the Toner Bottle Holder, and then remove the toner bottle.

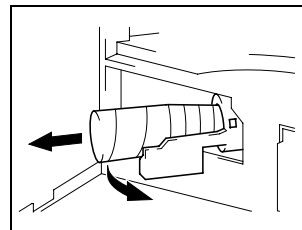

- 3** Holding the sealed end of the new toner bottle up, slowly peel off the seal toward you.

? *Have the necessary precautions been observed when peeling off the seal?*

- Since some toner may spurt out while the seal is being peeled off, be sure to peel off the seal slowly.

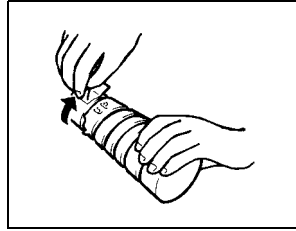

- 4** With the side of the toner bottle marked “UP” facing up, insert the toner bottle.

? *Have the necessary precautions been observed while inserting the toner bottle?*

- As shown at the right, the tab on the toner bottle should securely fit into the notch in the holder.

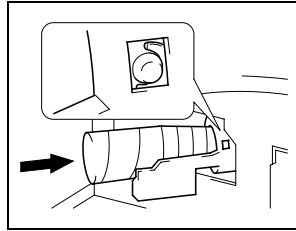

- 5** Lightly tap the bottom of the toner bottle three or four times.

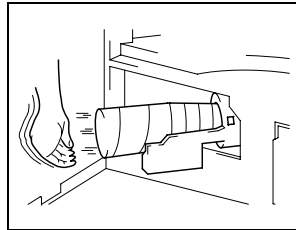

- 6** Close the Toner Bottle Holder, and then close the Front Cover.

When the Front Cover is closed, the toner automatically begins refilling.

? *Are copies faint immediately after the toner bottle is replaced?*

- Perform the “TONER REPLENISHER” function in the Utility mode (p. 9-18).

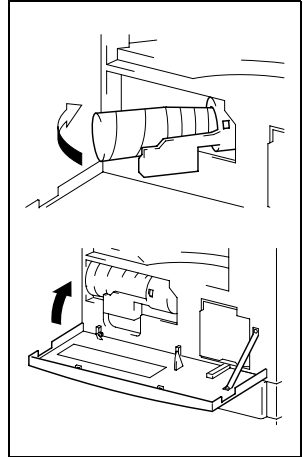

12.3 When the Message “PAPER JAM” Appears

If a paper misfeed occurs while copying or printing, the message shown below appears, and copying and printing stops.

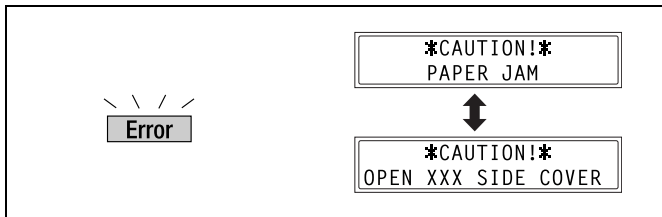

A message indicating the location of the paper misfeed appears in the bottom line of the screen.

Message	Location of the paper misfeed
OPEN 1st SIDE COVER	Manual Bypass Tray (p. 12-13) Inside the main unit or 1st Tray (p. 12-8)
OPEN 2nd (3rd/4th/5th) SIDE COVER	Paper Feed Cabinet (p. 12-12)

Follow the appropriate procedure described below to clear the misfed paper.

To clear a paper misfeed in the main unit or 1st Tray



CAUTION

The area around the fusing unit is extremely hot.

→ Touching any part other than the specified levers may result in burns.



CAUTION

There are hooks on the back of the guide plate.

→ Touching any part other than the paper may result in injuries.

- 1 Open the Side Cover of the main unit.

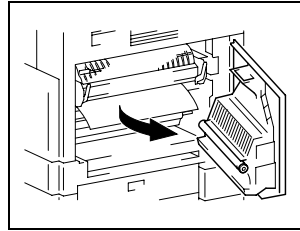

- 2 Pull down the Pressure Levers.

? *Have the necessary precautions been observed when pulling down the Pressure Levers?*

- Only hold the green part of the Pressure Levers when pulling them down.

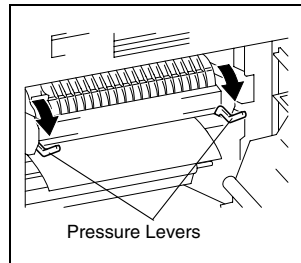

- 3 Slowly pull out the paper.

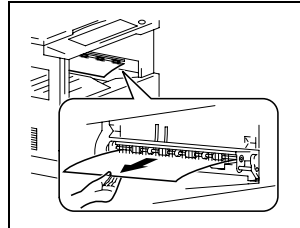

- 4 While holding the guide plate pressed down, slowly pull out the paper.

? *Have the necessary precautions been observed when pressing down the guide plate?*

- Only touch the green part of the guide plate when pressing it down.

- Do not touch the PC Drum (green), otherwise a malfunction could result.

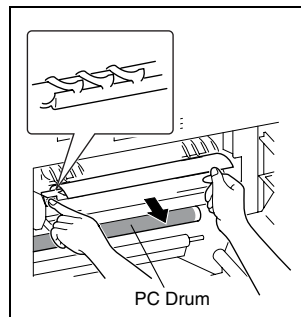

- 5 While turning the knob on the roller, slowly pull out the paper.

? *Have the necessary precautions been observed when turning the roller?*

- Only turn the green knob when turning the roller.

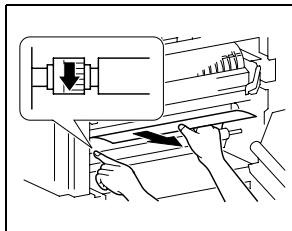

- 6 Return the Pressure Levers to their original positions.

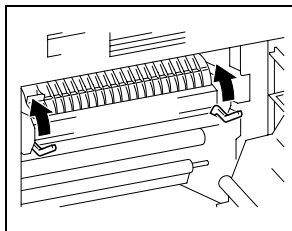

- 7 Close the Side Cover of the main unit.

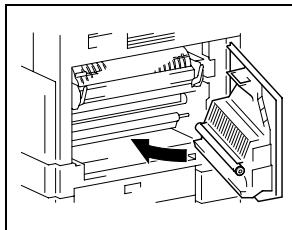

- 8 Pull out the 1st Tray, and then remove all paper from the tray. Load the paper into the tray again.

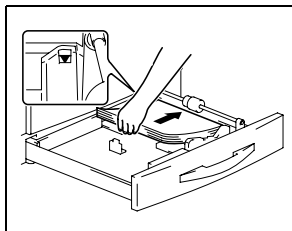

- 9** Slide the paper guides against the edges of the paper.

? *Is the paper guide positioned correctly?*

- Make sure that the paper guides are pushed up against the edges of the paper.

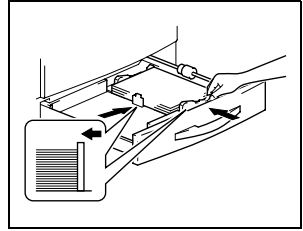

- 10** Close the 1st Tray.

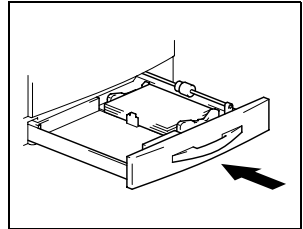

To clear a paper misfeed in the Paper Feed Cabinet

- 1 Open the Side Cover of the Paper Feed Cabinet.

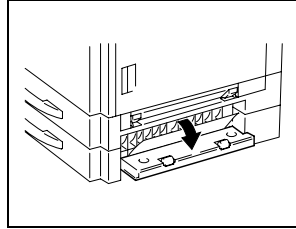

- 2 Slowly pull out the paper.

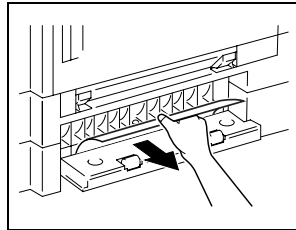

- 3 Close the Side Cover of the Paper Feed Cabinet.

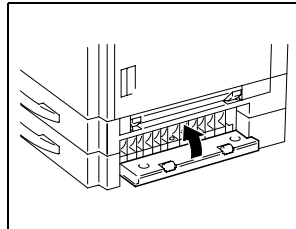

To clear a paper misfeed in the Multiple Bypass Tray

- 1 Remove all paper from the tray.

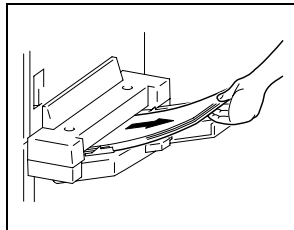

- 2 Open the Side Cover of the main unit.

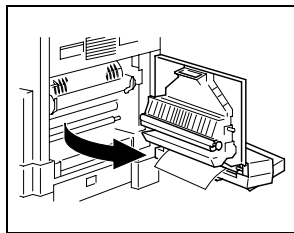

- 3 Slowly pull out the paper.

? *Have the necessary precautions been observed when pulling out the paper?*

- Do not touch the Transfer Roller, otherwise a malfunction could result.

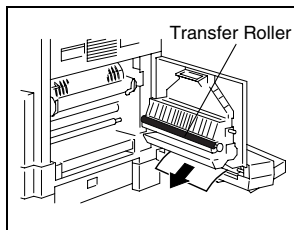

- 4 Close the Side Cover of the main unit.

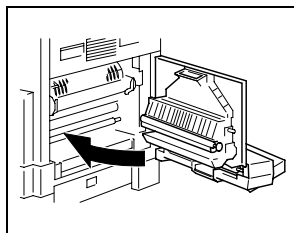

- 5 Load the paper into the Bypass Tray again.

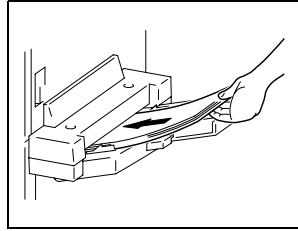

12.4 When the Message “ORIGINAL DOC.JAM” Appears

If a document misfeed occurs while the document is being fed, the message shown below appears, and copying and printing stops.

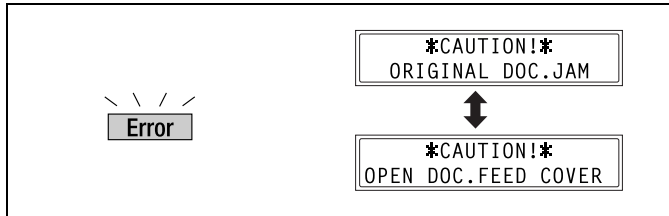

Remove the misfed document according to the following procedure.

To clear a misfeed in the Automatic Document Feeder

- 1 Open the Document Feeder Cover.

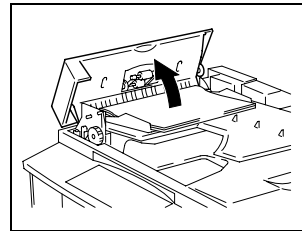

- 2 Remove all document pages from the Document Feeder Tray.

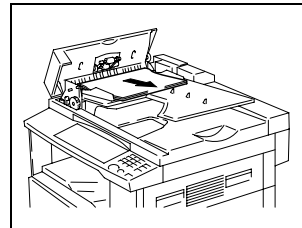

- 3** Lift open the Automatic Document Feeder.

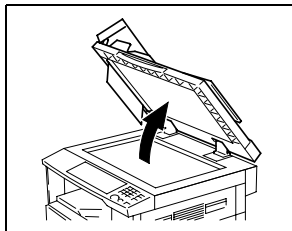

- 4** While turning the Document Feed Knob in the direction of the arrow, slowly pull out the document.

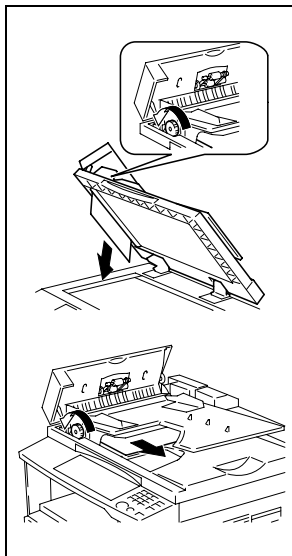

- 5** Close the Automatic Document Feeder and the Document Feeder Cover.

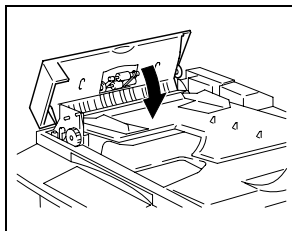



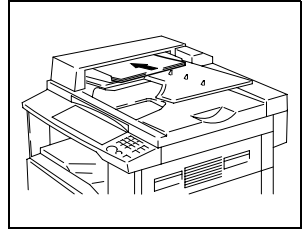



- 6 Load the documents removed in step 2 back into the tray.





**Note**

If “RETURN 1 (2) ORIG. to ADF and PRESS START KEY” appears on the display, also load the one or two document pages that caused the paper misfeed.

12.5 Main Error Messages and Their Remedies

Message	Cause	Remedy
PAPER JAM  (Flashing alternately) OPEN XXX SIDE COVER	A paper misfeed occurred in the main unit. All misfed paper was not removed from the main unit.	Open the cover at the indicated location, and then remove the misfed paper. ("When the Message "PAPER JAM" Appears" on page 12-8) Check the message in the display for the location of the paper misfeed, and then remove the misfed paper. ("When the Message "PAPER JAM" Appears" on page 12-8)
ORIGINAL DOC.JAM  (Flashing alternately) OPEN DOC.FEED COVER	A paper misfeed occurred in the Automatic Document Feeder. All misfed paper was not removed from the Automatic Document Feeder.	Open the Document Feeder Cover and the Automatic Document Feeder, and then remove the misfed paper. ("When the Message "ORIGINAL DOC.JAM" Appears" on page 12-15)
REMOVE PAPER IN BYPASS TRAY	Paper is loaded in the Manual Bypass Tray.	Remove the paper from the Manual Bypass Tray.
FRONT COVER OPEN  (Flashing alternately) CLOSE FRONT COVER	The Front Cover of the main unit is open or not securely closed.	Securely close the Front Cover.
DOCUMENT COVER OPEN  (Flashing alternately) CLOSE DOCUMENT COVER	The Automatic Document Feeder is lifted up (while a document is loaded into it).	Securely close the Automatic Document Feeder.
DOC.FEED COVER OPEN  (Flashing alternately) CLOSE DOC.FEED COVER	The Automatic Document Feeder Cover is open.	Securely close the Document Feeder Cover.
TONER EMPTY  (Flashing alternately) SUPPLY TONER	The toner is empty. Copying and printing cannot be performed.	Replace the toner bottle with a new one. ("To replace the toner bottle" on page 12-5)
PAPER EMPTY  (Flashing alternately) LOAD PAPER (#XXX)	The selected paper tray has run out of paper. "#" indicates the paper tray, and "XXX" indicates the paper size.	Load paper of the specified size into the specified paper tray.



Message	Cause	Remedy
SET ORIGINAL TO ADF	A document was not loaded into the Automatic Document Feeder before beginning a copy function (such as, "2in1" copying or "Mixed Orig." copying) that uses the Automatic Document Feeder. Otherwise, the Automatic Document Feeder is lifted up.	Load a document into the Automatic Document Feeder. Securely close the Automatic Document Feeder.
REMOVE PAPER	When interrupting a copy job to perform a different copy operation other than the "Book Separation" function, the document for the interrupted copy job was left in the Automatic Document Feeder.	Remove the document from the Automatic Document Feeder.
TEXT $\times 1.0$ ([A])#XXX:EMPTY 1	(While specifying copy settings) The selected paper tray has run out of paper. "#" indicates the paper tray, and "XXX" indicates the paper size.	Either load paper of the specified size into the specified paper tray, or press the [Paper] key and select a different paper size.
NO SUITABLE PAPER ⬆ (Flashing alternately) LOAD PAPER (#XXX)	<ul style="list-style-type: none"> While copying, the size of the paper in the selected paper tray has changed. While copying documents with mixed sizes using the "Auto Paper" function, paper of a suitable size could not be found. "#" indicates the paper tray, and "XXX" indicates the paper size. 	Either load paper of the specified size, or press the [Paper] key and select a different paper size.
APS SIZE ERROR	While copying using the "Auto Paper" function, paper of a suitable size could not be found.	Either load paper of a suitable size, or press the [Paper] key and select a different paper size.
AMS SIZE ERROR	While copying using the "Auto Size" function, the combination of the document and paper sizes caused the zoom ratio to exceed the range between $\times 0.5$ and $\times 2.0$.	Either load paper of a suitable size, or use the \blacktriangle and \blacktriangledown keys to specify the zoom ratio.
PAPER SIZE ERROR ⬆ (Flashing alternately) RESET PAPER (#XXX)	The paper loaded in the paper tray caused a size error. "#" indicates the paper tray, and "XXX" indicates the paper size.	Pull open the paper tray with the size error, and then close it again. Check if a custom paper size has been entered, and correct the paper size using the appropriate Utility mode function.

Message	Cause	Remedy
MEMORY FULL  (Flashing alternately) PRESS ANY KEY	The size of the data for the scanned image has exceeded the capacity of the memory.	Press the [Panel Reset] key, or turn the machine off, then on again. (The scanned data should be cleared from the memory.)
PC PRINT MEMORY FULL	The image data received from the computer has exceeded the capacity of the memory.	Press the [Panel Reset] key, or turn the machine off, then on again. (The received image data should be cleared from the memory.)
SET PLUG-IN COUNTER	A counter key is not inserted.	Insert the counter key.
UPPER TRAY FULL  (Flashing alternately) REMOVE PAPER	If the optional Job Tray is installed and the paper in the Upper Copy Tray has reached the maximum capacity, printing cannot continue.	Remove all paper from the Upper Copy Tray of the Job Tray.
TRAY MOVEMENT ERROR  (Flashing alternately) PRESS ANY KEY	The optional Job Tray is installed and the paper in either the Upper Copy Tray or the Lower Copy Tray has reached the maximum capacity when the machine is turned on, when copying begins, when receiving a fax, or when starting to print.	Remove the paper from the Upper Copy Tray or the Lower Copy Tray of the Job Tray, and then press the [Panel Reset] key.
LINE PROBLEM  (Flashing alternately) CHECK LINE	<ul style="list-style-type: none"> The telephone dialing system or telephone wiring system are not set correctly. The telephone cable is not attached correctly. 	<ul style="list-style-type: none"> Check the telephone dialing system or telephone wiring system and use the appropriate Utility mode function to make the correct settings. Correctly connect the telephone cable.
COMM.ERROR (####)	<ul style="list-style-type: none"> Communication is not possible because of some problem in the machine. Communication is not possible because of a problem with the recipient/caller's fax machine. 	Check the transmission results.
REDIAL ALL FAILED	All redial attempts failed because either the recipient's line is busy or there was no answer.	Check the condition of the recipient's line, and then try sending the fax again.
MEM.FULL/TX CANCEL	While sending a fax, the size of the data for the scanned image has exceeded the capacity of the memory.	<ul style="list-style-type: none"> Retrieve all received faxes stored in the memory. Send the fax by direct transmission.
MEM.FULL/RX CANCEL	While receiving a fax, the size of the data for the scanned image has exceeded the capacity of the memory.	Retrieve all received faxes stored in the memory.

Message	Cause	Remedy
CALL SERVICE(M1)	A maintenance is due.	Contact your service representative.
CALL SERVICE(M2)	The Imaging Unit should be replaced.	Contact your service representative.
MACHINE TROUBLE ⬆️ (Flashing alternately) (C####)	Some problem occurred in the machine.	Turn the machine off, then on again. If the error is still displayed, contact your service representative.

13 Troubleshooting

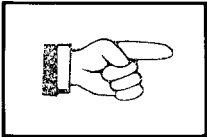
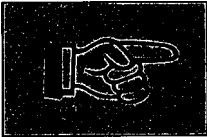

13.1 When Incorrect Copies Are Produced

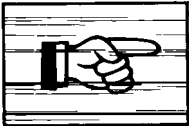
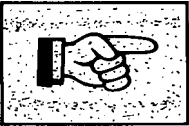
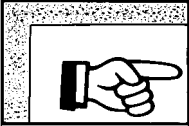
Symptom	Possible Cause	Remedy
The copy is too light. 	The copy density is set too light.	Use the Auto/Photo key to select a darker copy density (p. 4-25). ▶
	The copy paper is damp.	Replace the paper. (p. 12-1)
The copy is too dark. 	The copy density is set too dark.	Use the Auto/Photo key to select a lighter copy density (p. 4-25). ◀
	The document was not pressed close enough against the Original Glass.	Position the document so that it is pressed closely against the Original Glass. (p. 4-5)
The copy is blurry. 	The copy paper is damp.	Replace the paper. (p. 12-1)
	The document was not pressed close enough against the Original Glass.	Position the document so that it is pressed closely against the Original Glass. (p. 4-5)

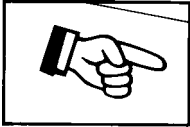
Symptom	Possible Cause	Remedy
<p>There are streaks through the copy.</p> 	The Original Glass is dirty.	Wipe the glass with a soft dry cloth. (p. 14-9)
	The document pad is dirty.	Clean the document pad with a soft cloth dampened with a mild detergent. (p. 14-9)
	The original is highly translucent, such as diazo photosensitive paper or OHP transparencies.	Place a blank sheet of paper over the document. (p. 4-6)
<p>There are specks throughout the entire copy.</p> 	A double-sided document is being copied.	If a thin double-sided document is being copied, the information on the back side may be reproduced in the copy. Use the Auto/Photo key ◀ to select a lighter density for the background. (p. 4-26)
	The edge of the copy is dirty.	The document pad is dirty.
	The selected paper size is larger than the document (with a zoom setting of ×1.00).	Select a copy paper size that is the same as the size of the document. (p. 4-11) Otherwise, select the "Auto Size" function to enlarge the copy to the selected paper size. (p. 4-21)
	The orientation of the document is different from the orientation of the copy (with a zoom setting of ×1.00).	Select a copy paper size that is the same as the size of the document. Otherwise, select a copy orientation that is the same as the orientation of the document.
	The copy was reduced to a size smaller than the copy (with a reduced zoom ratio).	Select a zoom ratio that adjusts the copy size to the size of the selected paper. (p. 4-22) Otherwise, select the "Auto Size" function to reduce the copy to the selected paper size. (p. 4-21)

Symptom	Possible Cause	Remedy
<p data-bbox="288 158 469 197">The image is not aligned properly on the paper.</p> 	<p data-bbox="526 158 678 197">The document is not positioned correctly.</p>	<p data-bbox="742 158 938 326">Correctly position the document against the Document Scales. (p. 4-1) If the Automatic Document Feeder is installed, correctly adjust the Document Guide Plates for the size of the document. (p. 4-1)</p>
	<p data-bbox="526 340 713 414">The document is not positioned correctly in the Automatic Document Feeder.</p>	<p data-bbox="742 340 934 431">Lift open the Automatic Document Feeder, and correctly position the document against the Document Scales. (p. 4-5)</p>
	<p data-bbox="526 443 703 518">The Document Guide Plates are not slid up against the edges of the document.</p>	<p data-bbox="742 443 938 501">Slide the Document Guide Plates against the edges of the document.</p>
	<p data-bbox="526 530 710 569">Curled paper was loaded into the paper tray.</p>	<p data-bbox="742 530 919 569">Flatten the paper before loading it.</p>

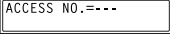
13.2 When Copying Is Not Performed Correctly

Symptom	Possible Cause	Remedy
Nothing appears on the display.	Only the [Start] key indicator is lit up in green.	The machine is in Energy Saver mode (preheat mode). Press any key to cancel Energy Saver mode. (p. 3-25)
	The "AUTO SHUT OFF" function was activated.	Set the Power Switch to "O" (p. 3-28).
The [Start] key indicator is not lit up in green.	A user (section) access number has not been entered. 	Enter the user (section) access number according to the instructions in "To enter an access number" on page 3-27
Even though the [Start] key is pressed, no copies are made.	If the "Error" indicator on the Control Panel is lit, an error has occurred.	Follow the instructions in any messages that appear on the display.
	If the machine was just turned on, it is still warming up.	The machine takes about 30 seconds to warm up after it is turned on.
The machine cannot be set to Copy mode.	The machine is in Interrupt mode (the "Interrupt" indicator is lit). 	Press the [Interrupt] key to cancel Interrupt mode. (p. 3-26)
The machine cannot be turned on.	The power supply cord has been unplugged from the electrical outlet.	Plug the power supply cord into the electrical outlet.
	The breaker for the electrical circuit has been tripped.	Close the breaker for the electrical circuit.

13.3 When Faxing Is Not Performed Correctly

Faxes Cannot Be Sent

Symptom	Possible Cause	Remedy
The document cannot be scanned.	The document is too thick.	Position the document on the Original Glass to send it. (p. 6-5)
	The document is too thin or too small.	Position the document on the Original Glass to send it. (p. 6-5)
	The Original Glass is dirty.	Wipe the glass with a soft, dry cloth. (p. 14-9)
The document was scanned at an angle.	The document is not positioned correctly.	Adjust the Document Guide Plates for the size of the document. (p. 6-3)
The fax received by the recipient is not clear.	The document is not positioned correctly.	Position the document correctly. (p. 6-3 and p. 6-5)
	The Original Glass is dirty.	Wipe the glass with a soft, dry cloth. (p. 14-9)
	The text in the document is too faint.	Adjust the scanning contrast. (p. 10-36)
	There is a problem with the telephone connection or with the recipient's fax machine.	Check that this machine can make clean copies. If it can, try sending the fax again.
The fax received by the recipient is blank.	The document was sent with the front side facing down (while using the Automatic Document Feeder).	Load the document with the front side facing up, and then try sending the fax again. (p. 6-3)
Faxes cannot be sent automatically.	The fax number is wrong.	Check the fax number.
	A number specifically for telephone calls is being dialed.	Check the number.
	There is a problem with the recipient's fax machine (it is out of paper, it is not set to receive faxes automatically, it is turned off, etc.).	Contact the recipient.

Faxes Cannot Be Received

Symptom	Possible Cause	Remedy
The received fax is not clear.	Paper that does not meet specifications has been used.	Use paper that meets specifications. (p. 3-39)
	The paper is damp.	Replace the paper. (p. 12-1)
	The toner is empty.	Replace the toner bottle with a new one. (p. 12-5)
	There is a problem with the telephone connection or with the caller's fax machine.	Check that the machine can make clean copies. If it can, have the caller send the fax again.
The received fax is blank.	The toner is empty.	Replace the toner bottle with a new one. (p. 12-5)
	The caller sent the back of the fax pages.	Contact the caller.
Faxes cannot be received automatically.	The machine is set to receive faxes manually.	Set the machine to automatic reception. (p. 10-45)
	The memory is full.	Load paper if it is empty, and then print the faxes stored in the memory.
	Some error occurred.	Follow the instructions in any messages that appear on the display. (p. 12-18)
Black streaks appear through the copy.	There is a problem with the telephone connection or with the caller's fax machine.	Check that the machine can make clean copies. If it can, have the caller send the fax again.

Calls Cannot Be Sent

Symptom	Possible Cause	Remedy
Nothing can be heard from the connected telephone.	The cord from the telephone is not connected correctly to the main unit.	Correctly connect the telephone cord to the main unit.
	The telephone cord from the wall jack is not connected correctly to the main unit.	Correctly connect the telephone cord from the wall jack to the main unit.
	Transmitting.	Check again after the transmission is finished.
After dialing, the ringing cannot be heard.	The telephone dialing system is not set correctly.	Correctly set the telephone dialing system. (p. 3-34)
After the [Speaker] key is pressed, it is difficult to hear the recipient/caller's voice.	The monitoring volume is too low.	Increase the monitoring volume. (p. 10-49)
The ringing of the telephone is too low (loud).	The ringer volume of the connected telephone is set too low (loud).	Adjust the ringer volume of the connected telephone.

14 Appendix

14.1 Specifications

Main Unit Di152*/Di152f/Di183*/Di183f

* Only when Fax unit for Di183/Di152 FX-1 is installed

Specification	Di152/Di152f	Di183/Di183f
Type	Desktop	
Platen	Stationary	
Photo conductor	OPC	
Copying system	Digital laser copying	
Developing system	MT-HG system	
Fusing system	Heat-roller-fixing system	
Resolution	600 dpi	
Document	Types: Sheets, books, and other three-dimensional objects Size: Maximum 11 × 17 L Weight: 6-1/2 lb	
Paper types	Plain paper (16 lb to 24 lb), recycled paper (16 lb to 24 lb) Special paper: Cards (24-1/4 lb to 41-3/4 lb), OHP transparencies, postcards, and label sheets * Special paper can only be fed through the 1st Tray and the Manual Bypass Tray.	
Paper sizes	1st Tray: 11 × 17 L to 5-1/2 × 8-1/2 Width: 3-9/16 inch to 11-11/16 inch, length: 5-1/2 inch and 17 inch In metric: A3 L to A5 C, FLS (8-1/4 × 13) Width: 3-9/16 inch to 11-11/16 inch, length: 5-1/2 inch and 17 inch * When the length is set between 16-9/16 inch to 17 inch, the maximum width that can be set is 11 inch. When the width is set between 11 inch and 11-11/16 inch, the maximum length that can be set is 16-9/16 inch. Manual Bypass Tray: Width: 3-9/16 inch to 11-11/16 inch, length: 5-1/2 inch to 17 inch	
Paper capacity	1st Tray: Plain or recycled paper: 250 sheets Special paper: 20 sheets Manual bypass tray: Plain, recycled or special paper: 1 sheet	
Warm-up time	Less than 30 seconds (at room temperature (73.4°F))	

Specification	Di152/Di152f	Di183/Di183f
First-page print time	Less than 7 seconds (using the 1st Tray loaded with Letter C)	
Copy speed	9 sheets/minute (11 × 17 L) 11 sheets/minute (Legal L) 13 sheets/minute (Letter L) 15 sheets/minute (Letter C)	11 sheets/minute (11 × 17 L) 12 sheets/minute (Legal L) 15 sheets/minute (Letter L) 18 sheets/minute (Letter C)
Magnification ratios	Full size: × 1.00 Enlargement ratios: × 1.21, × 1.29 and × 2.00 Reduction ratios: × 0.78, × 0.64, × 0.50 Zoom ratios: × 0.50 to × 2.00 (in 0.01 increments)	
Multiple copies	1 to 99 sheets	
Density control	Automatic, manual and photo manual	
Image loss	Leading edge: 3/16 inch, Trailing edge: 3/16 inch, Rear edge: 3/16 inch, Front edge: 3/16 inch	
Power requirements	AC 120 to 127 V, 9.3 A, 50/60 Hz	
Power consumption	Less than 1180 W	
Size	23-1/4 inch (width) × 24 inch (depth) × 19-1/4 inch (height)	
Weight	88 lb (including 2-1/4 lb for the Fax unit for Di183/152 FX-1)	
Standard Memory	Fax: 4 MB (Can be increased to a maximum of 12 MB) Copier: 32 MB (Can be increased to a maximum of 48 MB)	
Memory backup battery	Nickel-hydrogen battery (6 V, 280 mAh)	

Automatic Document Feeder AF-10

Specification	
Document feed method	Standard method: Single-sided documents Mixed document sizes: Single-sided documents
Document type	Standard method: Plain paper (13-1/4 lb to 29-1/4 lb) Mixed document sizes: Plain paper (16 lb to 24 lb)
Document size	Standard method: 11 × 17 L to 5-1/2 × 8-1/2 L Mixed document sizes: Combination of 11 × 17 L and Letter C, or Legal L and Letter L
Document loading capacity	Maximum 50 sheets (21-1/4 lb)
Power consumption	Less than 36 W
Size	23-11/16 inch (width) × 19-3/4 inch (depth) × 4-1/4 inch (height)
Weight	Less than 13-3/4 lb

Paper Feed Cabinet PF-120

Specification	
Paper types	Plain paper (16 lb to 24 lb), recycled paper
Paper sizes	11 × 17 L to 5-1/2 × 8-1/2 In metric: A3 L to A5 C, FLS (8-1/4 × 13)
Paper capacity	250 sheets
Power consumption	Less than 9 W
Size	23-1/4 inch (width) × 22 inch (depth) × 4-1/4 inch (height)
Weight	12 lb

Shifting Unit OT-103

Specification	
Shifting amount	1-1/8 inch
Paper capacity	250 sheets
Power consumption	Less than 63 W

Job Tray JS-202

Specification	
Paper types	Plain paper (16 lb to 24 lb), recycled paper Special paper: Cards (24-1/4 lb to 41-3/4 lb), OHP transparencies, postcards, and label sheets
Paper capacity	Upper Copy Tray: Plain or recycled paper: 100 Letter-size sheets, 50 sheets of other than Letter size (stacked up to 3/4 inch high) Special paper: 10 sheets Lower Copy Tray: Plain or recycled paper: 150 Letter-size sheets, 75 sheets of other than Letter size Special paper: 20 sheets
Power consumption	Less than 63 W

Multiple Bypass Tray MB-5

Specification	
Paper types	Plain paper (16 lb to 24 lb), recycled paper Special paper: Cards (24-1/4 lb to 41-3/4 lb), OHP transparencies, postcards, and label sheets
Paper sizes	Width: 3-9/16 inch to 11-11/16 inch; Length: 5-1/2 inch to 17 inch
Paper capacity	Plain or recycled paper: 50 sheets Special paper: 20 sheets
Power consumption	Less than 9 W
Size	(Maximum) 17-1/4 inch (width) × 17-1/4 inch (depth) × 5-1/2 inch (height)
Weight	6 lb

14.2 List of Utility/Function/Confirm Menu Commands

Utility Menu Commands

Manufacturer's default settings appear in bold.

Menu	Function	Settings
1 MACHINE SETTING	AUTO RESET	ON (0.5/1/2/3/4/5)/OFF
	ENERGY SAVE MODE	TIMER=1-240 min. (Default: 15)
	AUTO SHUT OFF	ON (TIMER=15-240 min.)/ OFF
	DENSITY (ADF)	MODE1/MODE2
	PRINT DENSITY	LIGHT to DARK (5 levels)
	LCD CONTRAST	LIGHT to DARK (4 levels)
	BUZZER VOLUME	HIGH/ LOW /OFF
	LANGUAGE	Default: ENGLISH
2 PAPER SOURCE	INITIAL MODE	COPY/FAX
	INCH/METRIC	(For each paper tray) INCH/METRIC
	TRAY1 PAPER	PLAIN /OHP/CARD AUTO /CUSTOM
3 USER MANAGEMENT	AUTO SELECT	(For each paper tray) DISABLE/ ENABLE FIXED/CONTINUE
	DRUM DEHUMIDIFY	—
4 ADMIN. MANAGEMENT	TONER REPLENISHER	—
	AUTO SHUT OFF	DISABLE/ ENABLE
	COPY TRACK	COPY TRACK MODE (ON/ OFF) ACCESS NO. REG. COPY TRACK DATA (DISPLAY / CLEAR)
	REMOTE MONITOR	LIMITED /FULL/OFF

Menu	Function	Settings
5 COPY SETTING 1	PAPER PRIORITY	A3 L/B4 L/A4 L/B5 L/A5 L/FLS L/ A4 C/B5 C/A5 C/11 × 17 L/ 11 × 14 L/LG L/LT L/HL L/LT C/ HL C/1ST/2ND/3RD*/4TH*/5TH*/ MULTI BYPASS (* Only with Di183/Di183f)
	DENSITY PRIORITY	AUTO/MANUAL/PHOTO
	DENSITY LEVEL(A)	LIGHT to DARK (3 levels)
	DENSITY LEVEL(M)	LIGHT to DARK (5 levels)
	BINDING POS.	LEFT/RIGHT
	MARGIN SETTING	WIDTH=0-20 (mm)*
	ERASE SETTING	LEFT/UPPER/FRAME (WIDTH=5 mm-20 mm)*
6 COPY SETTING 2	MIXED ORIGINAL	ON/OFF
	COPY PRIORITY	AP/AS/MANUAL
	OUTPUT PRIORITY	NON/SORT/GROUP
	4IN1 COPY ORDER	PATTERN1/PATTERN2
	CRISSCROSS MODE	ON/OFF
7 FAX REGISTRATION	ONE-TOUCH DIAL	For details, refer to page 10-3.
	SPEED DIAL	For details, refer to page 10-8.
	GROUP DIAL	For details, refer to page 10-13.
	PROGRAM DIAL	For details, refer to page 10-16.
	BATCH TX	For details, refer to page 10-25.
	MAILBOX	For details, refer to page 10-29.
	RELAY BOX	For details, refer to page 10-31.
8 TX OPERATION	SCAN CONTRAST	LIGHT to DARK (5 levels)
	RESOLUTION	STD/FINE/S/F/ H/T(STD/FINE/S/F)
	DEFAULT TX	MEM.TX/ADF TX
	HEADER	(This function cannot be set.)
	OT-DIAL IN COPY	DISABLE/ENABLE

Menu	Function	Settings
9 RX OPERATION	MEMORY RX MODE	ON/OFF
	NO.of RINGS	1-16
	REDUCTION RX	ON/OFF/CUT
	RX PRINT	MEMORY RX/PRINT RX
	RX MODE	AUTO RX/MANUAL RX
	FORWARD	ON/ON (PRINT)/ OFF
	FOOTER	ON/OFF
	SELECT TRAY	(For each paper tray) DISABLE/ENABLE
10 COMM.SETTING	TONE/PULSE	TONE/PULSE
	LINE MONITOR	HIGH/ LOW/OFF
	PSTN/PBX	PSTN/PBX
11 REPORTING	ACTIVITY REPORT	ON/OFF
	RESERV.REPORT	ON/OFF
	TX RESULT REPORT	ON/OFF
	RX RESULT REPORT	ON/OFF
12 INITIAL USER DATA	DATE	For details, refer to page 3-31.
	USER FAX NO.	For details, refer to page 3-32.
	USER NAME	For details, refer to page 3-33.

* When using the 10-Key Pad to enter a measurement, the values are entered in millimeters. The conversion ratio is shown below.
1 inch = 25.4 mm

Function Menu Commands

Menu	Settings
1 BROADCAST	Recipients
2 TIMER TX	Transmission time
3 MAILBOX TX	Recipient, mailbox ID and password
4 PRINT MAILBOX RX	Mailbox ID
5 POLLING TX	SINGLE/MULTI, polling ID and password
6 POLLING RX	Caller, polling ID and password
7 RELAY INITIATE	Recipient, relay box ID and password
8 CANCEL RESERV.	Select job
9 TX MODE	Memory transmission/direct transmission and recipient

Confirm Menu Commands

Menu	Function
TX/RX RESULT	—
TOTAL PAGE	TOTAL COUNT
	SIZE COUNT
	TOTAL SCAN
	TX PAGES
	RX PAGES
PRINT REPORT	TX RESULT REPORT
	RX RESULT REPORT
	ACTIVITY REPORT
	MEMORY DATA LIST
	MEMORY IMAGE LIST
	ONE TOUCH LIST
	SPEED DIAL LIST
	KEY SETTING LIST
	RELAY BOX LIST
	MACHINE STATUS
	CONFIGURATION PAGE
PCL FONT LIST	

14.3 Care of the Machine

Cleaning

Turn off the machine before cleaning it.

Housing

- Clean the surface of the housing by wiping it with a soft cloth dampened with a mild household detergent.

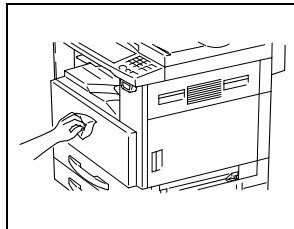

Original Glass

- Clean the Original Glass by wiping it with a soft, dry cloth.

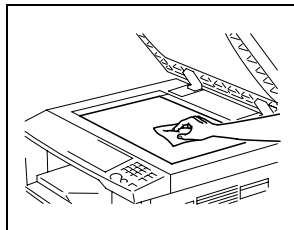

Document Pad

- Clean the surface of the document pad by wiping it with a soft cloth dampened with alcohol.

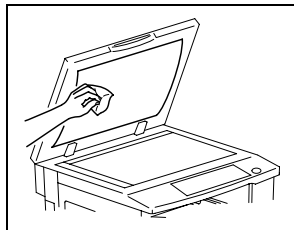

Control Panel

- Clean the Control Panel by wiping it with a soft, dry cloth.

**CAUTION**

Incorrectly cleaning the Control Panel keys may damage them. Never use mild household detergent or glass cleaner to clean the Control Panel.

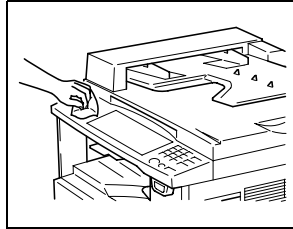

14.5 Paper Size and Zoom Ratio Tables

Copy Paper Sizes

Paper format	Size (millimeters)	Size (inches)
A3	297 mm × 420 mm	11-3/4 × 16-1/2
A4	210 mm × 297 mm	8-1/4 × 11-3/4
A5	148 mm × 210 mm	5-3/4 × 8-1/4
A6	105 mm × 148 mm	4-1/4 × 5-3/4
B4	257 mm × 364 mm	10 × 14-1/4
B5	182 mm × 257 mm	7-1/4 × 10
B6	128 mm × 182 mm	5 × 7-1/4
Postcard	100 mm × 148 mm	4 × 5-3/4

Paper format		Size (inches)	Size (millimeters)
Ledger		11 × 17	279 mm × 432 mm
11 × 14		11 × 14	279 mm × 356 mm
Computer		10-1/8 × 14	257 mm × 356 mm
10 × 14		10 × 14	254 mm × 356 mm
9-1/4 × 14		9-1/4 × 14	236 mm × 356 mm
Legal		8-1/2 × 14	216 mm × 356 mm
Foolscap	Government Legal	8-1/2 × 13	216 mm × 330 mm
Foolscap		8 × 13	203 mm × 330 mm
Foolscap		8-2/3 × 13	220 mm × 330 mm
Foolscap	Folio	8-1/4 × 13	210 mm × 330 mm
8-1/4 × 11-3/4		8-1/4 × 11-3/4	210 mm × 301 mm
Letter		8-1/2 × 11	216 mm × 279 mm
Government Letter		8 × 10-1/2	203 mm × 267 mm
Quarto		8 × 10	203 mm × 254 mm
Statement	Invoice	5-1/2 × 8-1/2	140 mm × 216 mm

Zoom Ratios

Metric sizes		
Document size	Paper size	Zoom ratio
A3 297 mm × 420 mm 11-3/4 × 16-1/2	A4	× 0.70
	A5	× 0.50
	B4	× 0.86
	B5	× 0.61
A4 210 mm × 297 mm 8-1/4 × 11-3/4	A5	× 0.70
	A6	× 0.50
	B5	× 0.86
	B6	× 0.61
	A3	× 1.41
A5 148 mm × 210 mm 5-3/4 × 8-1/4	B4	× 1.22
	A6	× 0.70
	B6	× 0.86
	A4	× 1.41
	A3	× 2.00
A6 105 mm × 148 mm 4-1/4 × 5-3/4	B4	× 1.73
	B5	× 1.22
	A4	× 2.00
	A5	× 1.41
	B5	× 1.73
B4 257 mm × 364 mm 10 × 14-1/4	B6	× 1.22
	A4	× 0.81
	A5	× 0.57
	B5	× 0.70
	B6	× 0.50
B5 182 mm × 257 mm 7-1/4 × 10	A3	× 1.15
	A5	× 0.81
	A6	× 0.57
	B6	× 0.70
	A3	× 1.63
	A4	× 1.15
B4	× 1.41	

B6 128 mm × 182 mm 5 × 7-1/4	A6	× 0.81
	A4	× 1.64
	A5	× 1.15
	B4	× 2.00
	B5	× 1.41

English sizes		
Document size	Paper size	Zoom ratio
11 × 17 279.4 mm × 431.8 mm	11×14	× 0.82
	Legal	× 0.77
	Foolscap	× 0.75
	Letter	× 0.64
	Invoice	× 0.50
11 × 15 279.4 mm × 381 mm	11 × 14	× 0.93
	Legal	× 0.75
	Foolscap	× 0.77
	Letter	× 0.73
	Invoice	× 0.50
11 × 14 279.4 mm × 355.6 mm	Legal	× 0.77
	Foolscap	× 0.77
	Letter	× 0.77
	Invoice	× 0.50
Legal 8-1/2 × 14 215.9 mm × 355.6 mm	Foolscap	× 0.92
	Letter	× 0.78
	Invoice	× 0.60
	11 × 17	× 1.21
Foolscap 8-1/2 × 13 215.9 mm × 330.2 mm	Letter	× 0.84
	Invoice	× 0.65
	11 × 17	× 1.30
	11 × 14	× 1.07
Letter 8-1/2 × 11 215.9 mm × 279.4 mm	Invoice	× 0.64
	11 × 17	× 1.29
	11 × 14	× 1.27

Invoice 5-1/2 × 8-1/2 139.7 mm × 215.9 mm	11 × 17	× 2.00
	11 × 14	× 1.64
	Legal	× 1.54
	Foolscap	× 1.50
	Letter	× 1.29

Zoom ratio=Paper size/Document size

1 inch = 25.4 mm

1 mm = 0.0394 inch

14.6 Power Outages

Even if a power outage occurred, transmission and reception information are stored in the memory for about 10 hours. After 10 hours, all stored information is lost. If a document is lost due to a power outage, a memory clear report is automatically printed after the power is restored and the machine is turned on.

With this report, the document number and recipient information for the lost fax can be retrieved.

Information programmed in one-touch dial keys are not lost during a power outage. There is no need to re-program the one-touch dial keys.

If there is a power outage or the machine is turned off, calls cannot be made or received.

If a telephone not powered by electricity is connected to the machine, the telephone can be used, even during a power outage.

The telephone where documents are stored for two hours cannot be used to make or receive calls.

14.7 Glossary

Terms and Definitions

Term	Definition
Automatic redialing	If a call cannot be completed, for example if the recipient's machine is busy, the recipient is automatically called again. If a document queued in the memory to be sent contains multiple pages, until the time for redialing has been reached, it is advanced in the queue and sent.
Book document	A bound document such as a book or catalog.
F codes	F codes are mailbox functions, such as "SUB" (sub-addresses), "SEP" (selective polling), "SID" and "PWD" (passwords), regulated by the G3 standards of the ITU-T (International Telecommunication Union). Mailbox transmission/reception and relay initiation transmission are possible only with similar machines compatible with F code transmission.
G3 communication	Communications in conformance with the G3 standard (an international standard for facsimile communications); fax communications via an analog line (general subscriber line).
Internet fax	Faxes can be transmitted via the Internet or an Intranet instead of through telephone lines. Instead of a fax number, the recipient's e-mail address is specified and the scanned image (TIFF format) can be sent as an e-mail message to a computer or Internet fax. In addition, e-mail messages from computers can be received as images.
General subscriber line	Analog telephone lines (public network)
JBIG coding method	New method of data compression/decompression, standardized by the Joint Bi-level Image Expert Working Group, a subcommittee of the International Telecommunications Union (ITU-T). Effective for transferring large amounts of data or high-resolution image data such as halftones.
Manual reception	Receiving a fax document after talking on the telephone.
Manual transmission	Sending a fax document after talking on the telephone.
Memory	Stores fax and copy image data. By installing expansion memory, much more image data can be stored in the memory.
Memory reception	When paper runs out or a paper misfeed occurs while receiving a fax, the data is automatically stored in the memory and printed out later. Even if the paper runs out during the night or when the user is away, the fax document can still be received.
Network scanner	This is a function that allows scanned images to be sent to a computer via a network. They can also be sent as e-mail messages or uploaded to FTP servers.
On-hook dialing	Dials without the hand set picked up. Press the [On-hook dial] key to use this function.

Term	Definition
PBX	Abbreviation for private branch exchange Exchange equipment installed in a company or a plant to connect a number of telephone sets with multiple station lines in order to enable unrestricted communications between the telephone sets.
Protocols	The necessary rules for communication
Touch-tone signals	A signal used on the telephone line; used when calling on a push-button line or using push-button services. By pressing the [X] key in the 10-Key Pad, touch-tone signals are used, even if a dial phone line is connected.

15 Index

Numerics

1st Tray paper setting	9-14
2in1 copying	5-2
4in1 copying	5-2

A

Access numbers	3-26
Activity report	10-51
Administrative settings	9-19
Auto panel reset	3-24, 9-4
Auto paper	4-11
Auto paper source change	3-26
Auto Select function	9-16
Auto shut-off	3-25, 9-6
Administrative setting	9-21
Automatic Document Feeder	9-7, 14-2
Automatic paper size detection units	9-13
Automatic reception	6-20

B

Batch transmission	7-3
Setup	10-25
Binding margin	5-13
Book separation	5-3
Book transmission	7-1
Broadcast transmission	7-4
Buzzer volume	9-9

C

Cancelling queued document	7-19
Cancelling settings	3-24
Care of the machine	14-9
Combination dialing	6-16

Communication settings	
Monitoring volume	10-49
Components	3-8
Control Panel	3-18
Access key	3-27
Energy Saver key	3-25
Interrupt key	4-27
Panel Reset key	3-24
Copy density	4-25
Setting	4-26
Copy functions	
4in1 Copy Order	9-39
Binding position	9-35
Binding width	9-36
Copy priority	9-38
Crisscross output	9-40
Default density level (Auto)	9-34
Default density level (Manual)	9-35
Default finishing mode	9-39
Default mixed originals setting	9-38
Density priority	9-34
Erased width	9-36
Priority paper size or tray	9-33
Copy program	
Recalling	5-16
Storing	5-15
Copying	
Simple copying	4-9
Current date and time	3-31
Custom paper size	4-19

D

Default settings	3-29, 9-2
Dialing	6-10
Direct transmission	7-14
Document misfeed	12-15
Documents for transmission	6-1
Drum dehumidifying	9-17

E

Energy Saver mode	3-25, 9-5
Entering text	3-36
Erase function	5-9
Error messages	12-18

F

F codes	7-25
Fax resolution	6-8
Fax transmission	
Basic faxing	6-3
Dialing	6-10
Loading documents into the Automatic Document Feeder	6-3
Positioning documents on the Original Glass	6-5
Finishing copies	5-5
Grouping	5-7
Sorting	5-6
Function combination table	14-11

G

Group dialing	6-14
Setup	10-13

I

Incorrect copies	13-1
Initial mode	9-10
Installation site	2-1
Interrupting copy jobs	3-26, 4-27

J

Job Tray	14-3
----------------	------

L

Language setting	9-9
LCD contrast	9-8
Legal restrictions on copying	2-5

Loading documents	4-1
Automatic Document Feeder	4-1
Books	4-7
Mixed sizes	4-2
OHP transparencies	4-6
Original Glass	4-5
Translucent or transparent documents	4-6
Loading paper	12-1
1st Tray	12-1
2nd (3rd/4th/5th) Tray	12-3
Multiple Bypass Tray	12-4

M

Machine settings	9-2
Mailbox reception	7-22
Mailbox setup	10-29
Mailbox transmission	7-9
Main unit	3-10
Manual feeding	4-14
Custom paper size	4-19
Manual paper selection	4-12
Manual reception	6-20, 7-21
Manual transmission	7-1
Memory full	6-7
Memory reception	7-21
Menu commands	14-5
Multiple Bypass Tray	14-4

N

Negative/positive inverted copying	5-12
--	------

O

One-touch dialing	6-12
Setup	10-3
Operation precautions	2-3

Options

Automatic Document Feeder	3-13
Job Tray	3-17
Multiple Bypass Tray	3-14
Paper Feed Cabinet	3-15
Shifting Unit	3-16

P

Paper Feed Cabinet	14-3
Paper feeding	1-17
Paper misfeed clearing	12-8
Automatic Document Feeder	12-15
Main unit	12-8
Multiple Bypass Tray	12-13
Paper Feed Cabinet	12-12
Paper orientation	1-18
Paper size and zoom ratio tables	14-12
Paper source	4-11
Setup	9-11
Paper specifications	3-39
PC faxing	8-1
PC scanning	8-1
Phone book	6-17
Phone dialing system	3-34
Phone wiring system	3-35
Polling reception	7-23
Polling transmission	7-16
Power outage	14-16
Power source	2-1
Power Switch	3-28
Preheat mode	3-25, 9-5
Printing	3-27
Program dialing	6-15
Setup	10-16
Programming fax settings	10-1

Q

Queued copy jobs	3-25
Queued jobs report	10-52

R

Reception result report	10-53
Reception settings	
Footer printing	10-47
Forwarding setup	10-46
Memory reception mode	10-42
Number of rings	10-44
Printing mode	10-45
Reception mode	10-45
Reduced printing	10-44
Tray selection	10-47
Relay box setup	10-31
Relay broadcast transmission	7-13
Relay initiation transmission	7-11
Remote monitor	9-30

S

Scanning	3-27
Scanning image quality	9-7
Shifting Unit	14-3
Space requirements	2-2
Specifications	14-1
Speed dialing	6-13
Setup	10-8

T

Timer transmission	7-7
Toner replenishing	9-18, 12-5
Total count	11-1
Transmission result report	10-52
Transmission results	6-22
Transmission settings	
Default transmission mode	10-38
Resolution	10-37
Scanning contrast	10-36
Turning on/off	3-28

U

User fax number	3-32
User management	
Administrative settings	9-22
User name	3-33
User-managed service tasks	9-17
Utility mode	9-1, 10-1
Copy Setting 1	9-32
Copy Setting 2	9-37

Z

Zoom setting	4-21
Auto zoom ratio	4-21
X/Y zoom function	4-23



**Copyright
2001 MINOLTA CO., LTD.**

The information contained in this manual is subject to change without notice to incorporate improvements made on the product or products the manual covers.

MINOLTA CO., LTD.

2001. 12

3-13, 2-chome, Azuchi-Machi, Chuo-ku, Osaka. 541-8556, Japan

7664-4506-01